

\$4.50



Kennedy Hardware

ANTIQUE RESTORATION HARDWARE & SUPPLIES
10655 Andrade Drive • Zionsville, Indiana 46077
Phone (317) 873-1316



Catalog No. 27



Kennedy Hardware is located in a small industrial park in Zionsville, Indiana just outside the Northwest edge of Indianapolis. Our sales room is open from 9:00AM to 4:00PM Monday through Friday. See the map below for directions.



Sales Counter



Warehouse



Kennedy Hardware
10655 Andrade Drive
Zionsville, Indiana 46077

From I-465 take Michigan Road north one mile to 106th Street (700S). Go west on 106th Street approximately 1/3 mile to Andrade Drive.

To place an order call: **1-800-621-1245**

For information call: **1-317-873-1316**

24 Hour FAX Line: **1-317-873-8662**

Order On-Line at:

www.kennedyhardware.com

Popular Hardware

Bin Pulls



Page 2

Cabinet Latches



Page 3

Casters



Page 4

Hoosier Latches



Page 6

Hinges

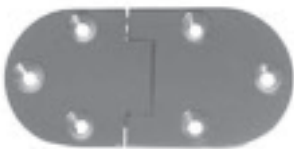

Page 42

IceBox Latches



Page 21

Stamped Brass Pulls



Page 23

Cast Brass Pulls



Page 24

Glass Knobs



Page 35

Waterfall Hardware



Page 27

Keys



Page 40

Sample Key Rings



Page 41

Locks



Page 37

Trunk Handles



Page 68

See Index on Page 72

Bin Pulls

Stamped Brass Bin Pulls



Stamped brass bin pulls.
3-1/2" x 1-5/8"
3" Boring

- B-16** Polished Brass
- B-16AC** Antique Copper Finish
- B-16N** Nickel Plated



Heavy stamped brass bin pulls. For applications where a sturdier bin pull is desired. Size: 3-3/8" x 1-5/8"
3" Boring

- B-16X** Polished Brass
- B-16XN** Nickel Plated
- B-16XORB** Oil Rubbed Bronze

Cast Brass Bin Pulls



Classic cup bin pull. Cast Brass.
Overall Size: 3-3/4" x 1-1/8"
3-3/8" Boring

- B-36B** Polished Brass
- B-36HAC** Antique Copper*
- B-36BN** Brushed Nickel Finish
- B-36N** Nickel Plated
- B-36ORB** Oil Rubbed Bronze

*Hand Aged Copper Plated



- B-27** Cast Brass Bin Pull
3-1/2" x 1-1/4"
3" Boring

Cast Brass or Iron Bin Pull



This bin pull with interesting detail is available in either cast brass or cast iron. Size: 4-1/4" x 1-1/8"
3-1/2" Boring

- B-38** Cast Brass
- BB-38CI** Cast Iron Painted Black

Matching Cast Brass Bin Pulls



- B-33A** Cast Brass Bin Pull
3-1/4" x 3/4"
2-3/4" Boring



- B-33B** Cast Brass Bin Pull
3-5/8" x 7/8"
3" Boring



- B-33C** Cast Brass Bin Pull
4" x 1"
3-1/2" Boring

Cast Iron Bin Pulls

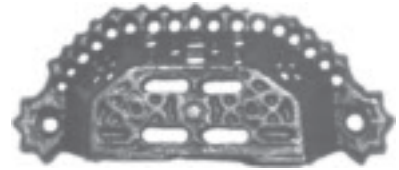

- BB-15CI** Cast Iron Bin Pull
Painted Black
4-1/4" x 1-3/4"
3-3/8" Boring



- BB-16CI** Cast Iron Bin Pull
Painted Black
3-1/2" x 1-3/8"
3" Boring



- BB-17CI** Cast Iron Bin Pull
Painted Black
4-1/8" x 2"
3-1/4" Boring



- BB-18CI** Cast Iron Bin Pull
Painted Black
3-3/8" x 1-3/8"
2-15/16" Boring



- BB-31CI** Cast Iron Bin Pull
Very Nice. Not Painted
3-3/8" x 1-1/2"
2-7/8" Boring

Cabinet Latches

Stamped Latches

Stamped steel cabinet latches available in two sizes.



Small Cabinet Latch

Overall Size: 1-3/4" High x 1-3/4" Wide. Catch Width: 1/2"

BI-15A Brass Plated

BI-15A/AB Antique Brass Finish

BI-15A/AC Antique Copper Finish

BI-15AN Nickel Plated

BI-15A/ORB Oil Rubbed Bronze



Large Cabinet Latch

Overall Size: 2-1/4" High x 2-1/4" Wide. Catch Width: 5/8"

BI-15 Brass Plated

BI-15AB Antique Brass Finish

BI-15AC Antique Copper Finish

BI-15N Nickel Plated

BI-15ORB Oil Rubbed Bronze

Cast Brass Latches



Cast brass cabinet latch. Overall Size: 2-3/4" Wide x 1-1/4" High. Catch Width: 1"

BI-14 Cast Brass Cabinet Latch



Cast brass cabinet latch. Overall Size: 3-1/4" Wide x 1-1/2" High. Catch Width: 1"

BI-20 Cast Brass Cabinet Latch

Cast Brass Latches



Fine quality cast brass cabinet latch. Overall Size: 1-3/4" High x 1-3/4" Wide. Catch Width: 1/2"

BI-32 Brass

BI-32AB Antique Brass

BI-32BN Brushed Nickel

BI-32N Nickel Plated

BI-32ORB Oil Rubbed Bronze



Plain cast brass cabinet latch. Overall Size: 2" High x 2-1/4" Wide. Catch Width: 5/8"

BI-34 Solid Brass

BI-34BN Brushed Nickel

BI-34N Nickel Plated

BI-34ORB Oil Rubbed Bronze



Reproduction of an antique cast brass cupboard latch. Very good quality. Overall Size: 2-1/8" High x 2-3/16" Wide. Catch Width: 5/8"

BI-43 Cabinet Latch

Cast Iron Latches



Cast iron cabinet latch with white porcelain knob. Overall Size: 2-3/4" Wide x 1-1/4" High. Catch Width: 1"

BI-13CI Cast Iron Cabinet Latch



Cast iron cabinet latch with brass knob. Overall Size: 3-1/8" Wide x 1-1/2" High. Catch Width: 1-1/8"

BI-19CI Cast Iron Cabinet Latch



Plain cast iron cabinet latch. Overall Size: 1-3/4" Wide x 1-3/4" High. Catch Width: 1/2" **Lacquered**

BI-45CI Cast Iron Cabinet Latch

Casters

Wood Casters

Replacements for original wood casters used on most old American furniture. Brass plated fork. **Caster sockets are not included.**



C-4 1-1/8" Dia. Wheel. Set of 4



C-4B 1-5/8" Dia. Wheel. Set of 4



Large wood caster with ball bearing.
C-4C 2" Dia. Wheel. Set of 4

Caster Sockets



Replacement socket for wood casters shown above. **Sold Each**
C-4I Caster Socket

Porcelain Casters



Porcelain caster with steel fork.
Wheel: 1-1/8" Dia. X 9/16" Wide
Stem: 1/4" Dia. X 1-1/2" Long
CP-2 Porcelain Caster



Porcelain caster with solid brass stem and fork. 1/4" stem has 1" Dia. mounting plate
C-3CPW 1" Dia. Wheel



Porcelain caster with solid brass stem and fork. 1/4" drive stem has 1-1/8" Dia. mounting plate.
C-2AP 1" Dia. Wheel

Brass Casters



Brass caster with 1/4" tap-in stem to mount caster.
C-1 3/4" Dia. Brass Wheel



Brass caster with 1/4" tap-in stem to mount caster.
C-3C 1" Dia. Brass Wheel



Brass caster. 1/4" drive stem with 1-1/8" Dia. mounting plate. 1" Dia. Brass Wheel.
C-2A Polished Brass
C-2AB Antique Brass
C-2N Nickel Plated

Brass Plate Casters



Brass plate caster. 3/8" stem with 7/8" Diameter mounting plate. 3/4" Diameter wheel.

C-22 Polished Brass
C-22AB Antique Brass



Brass plate caster. 1/2" stem with 1" Diameter mounting plate.

1" Diameter brass wheel.
C-23 Polished Brass
C-23AB Antique Brass

Rubber Caster



Antique brass plated fork with 2" rubber wheel. Includes insert.

CR-98 Rubber Caster

Brass Cup Casters



Solid brass cup caster with a 1" diameter brass wheel. This is a Philadelphia pattern caster in unlacquered brass finish. The wheel is 1" in diameter and 1/2" in width. The inside diameter of the cup is 1" at the top and 5/8" at the bottom. The cup has three holes for mounting and is 1-1/16" tall. The total height of this caster is 2-1/4".

C-72 Round Cup Caster



Solid brass round cup caster with brass wheel in unlacquered brass. This caster has a 1- 1/4" diameter brass wheel. The inside diameter of the cup is 1-1/4" at the top and 15/16" at the bottom. The cup has three holes for mounting and is 1 3/8" tall. The total height of this caster is 2 5/8". The measurement from the bottom of the cup to the bottom of the wheel is 1-3/8".

C-74 Round Cup Caster



Solid brass square cup caster with brass wheel. Unlacquered brass. The caster has a 1" diameter brass wheel. The inside dimension of the cup is 1" at the top of the cup and 3/4" at the bottom. The overall height of the caster is 2-1/2"

C-88 Square Cup Caster

Hoosier Cabinet Hardware

Hoosier "H" Latch

Reproduction of the Hoosier company latch with traditional "H" motif. Housing: 1-1/8" x 2-1/4". Supplied with both 3/8" offset and flush catches. **Latch can be used for left or right doors.**



I-23 Brass
I-23N Nickel Plated

Hoosier Bullet Catches

Replacements for the original "bullet-type" catches used on many Hoosier brand cabinets.



Offset

Flush

HC-2 Brass
HC-2N Nickel Plated
HC-2F Brass
HC-2FN Nickel Plated

Plain Hoosier Latch

Hoosier style latch includes both flush and 3/8" offset catches. Housing: 1-1/8" x 2-1/4". **Latch can be used for left or right doors.**



KC-2 Brass
KC-2N Nickel Plated

Oval Hoosier Latch

Oval latch used on older Hoosier brand cabinets. Spring Loaded. Housing: 1" x 2". Includes 3/8" offset and flush catches. **Latch can be used for left or right doors.**



KC-6 Brass
KC-6N Nickel Plated
KC-6HAC Hand Aged Antique Copper

Ring Style Latch

Ring style latch similar to latches used on early Wilson, Sellers, Napanee and other cabinets. Includes flush and 3/8" offset catches. Housing: 1-1/4" x 2"



Left

Right

KC-10 Brass
KC-10N Nickel Plated
KC-10HAC Hand Aged
Antique Copper

KC-12 Brass
KC-12N Nickel Plated
KC-12HAC Hand Aged
Antique Copper

Sellers "S" Latch

Reproduction of popular Sellers latch with "S" motif. Housing: 1-1/8" x 2-1/4". Includes both flush and 3/8" offset catches.



Left

Right

KC-22 Brass
KC-22N Nickel Plated

KC-24 Brass
KC-24N Nickel Plated

Hand Aged Antique Copper Finish

The hand aged copper is a finish exclusive to Kennedy Hardware. The brass hardware is sent out to a local plating company to be copper plated. Each piece is carefully aged and then hand rubbed to achieve the authentic antique copper look. Our goal is to make each piece look as if it was last hand polished 50 years ago.

Lever Latches

Replacements for the lever type latches used on Boone, Sellers, Napanee and other cabinets. Both the latch and the catch are cast brass. Latch base is 1-9/16" High x 3/4" Wide. Overall Length: 2-3/4"



Left

Right

Lever Latches with Flush Catches

Lever latch with flush catch. Use this latch for applications that require a flush catch. Catch base is 1-9/16" High x 3/4" Wide.

- KC-14** Polished Brass Left Latch with Flush Catch
- KC-14N** Nickel Plated Left Latch with Flush Catch
- KC-15** Polished Brass Right Latch with Flush Catch
- KC-15N** Nickel Plated Right Latch with Flush Catch



Left

Right

Lever Latches with Offset Catch

Lever latch with 3/8" offset catch. Use this latch for applications that require an offset catch. Catch base is 1-5/8" High x 1/4" Wide.

- KC-16** Polished Brass Left Latch with Offset Catch
- KC-16N** Nickel Plated Left Latch with Offset Catch
- KC-17** Polished Brass Right Latch with Offset Catch
- KC-17N** Nickel Plated Right Latch with Offset

Catches



Elbow Catch

Hidden catch for doors without an external latch. When two doors meet an elbow catch is used to hold the left door closed. The latch on the right door engages the catch mounted on the left door.

- BP-93** Brass Plated
- BP-93A** Bronze
- BP-93N** Nickel Plated



BP-48

BP-94

Door Catches

Catches for doors without an external latch. Latch mounts on underside of shelf and catch mounts on inside of door.

- BP-48** Spring Steel. Brass Plated
- BP-94** Spring Loaded. Zinc Plated Steel

Extra Catches for Hoosier Latches



Set of four catches for many Hoosier type latches. Designed to be used with either left or right latches. Includes two flush catches and two offset catches.

- I-23M** Polished Brass

Catches for Seller "S" Latches



Replacement catches for Sellers "S" latches. Can be used with left or right latches. Includes one flush catch and one 3/8" offset catch.

- I-50S** Polished Brass
- I-50SN** Nickel Plated

Hoosier Cabinet Hardware



Hoosier Cabinet Hinge

Our most popular Hoosier style hinge. 2-1/4" Wide x 1-1/2" High. 3/8" Offset.
I-11 Polished Brass
I-11N Nickel Plated



Hoosier Cabinet Hinge

Hinge used by Boone, Sellers and other cabinets. 2-1/4" Wide x 1-1/4" High. 3/8" Offset.
I-39 Polished Brass
I-39HAC Hand Aged Antique Copper
I-39N Nickel Plated

Hoosier Hinges

Exact replacement hinges for many Hoosier brand cabinets.



Smaller hinge used on the upper doors of Hoosier cabinets. 1-5/8" Wide x 1-1/2" High. 3/8" Offset.
I-33 Polished Brass
I-33N Nickel Plated



Large hinge used on lower doors of Hoosier cabinets. 1-3/4" Wide x 2" High. 3/8" Offset.
I-34 Polished Brass
I-34N Nickel Plated



Hoosier Cabinet Hinge

Hinge for Napanee and other cabinets. 1-3/4" Wide x 1-1/4" High. 3/8" Offset.
I-37 Polished Brass
I-37N Nickel Plated



Hoosier Cabinet Hinge

Fold-back hinge used on some Napanee cabinets and other Hoosier-type cabinets. 2-1/4" Wide x 1-1/4" High. 3/8" Offset.
I-38 Polished Brass
I-38N Nickel Plated

McDougall Hinges

Exact replacement hinges for many McDougall brand cabinets.

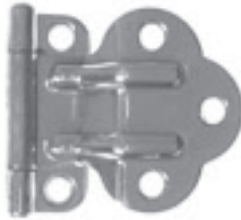

Fold-back hinge used on the outer upper and lower doors. 2" Wide x 1-3/4" High. 3/8" Offset.
I-40 Polished Brass
I-40HAC Hand Aged Antique Copper
I-40N Nickel Plated



Hinge used on the center doors in the upper section of McDougall cabinets. 1-7/8" Wide x 1-3/4" High. 3/8" Offset.
I-41 Polished Brass
I-41HAC Hand Aged Antique Copper
I-41N Nickel Plated

Sellers Hinges

Exact replacement hinges for many Sellers brand cabinets.



Hinge used on the outer upper doors of many Sellers cabinets. 3-1/4" Wide x 1-1/2" High. 3/8" Offset.
 Short Leaf: 1-5/16" x 1-1/2"
 Long Leaf: 1-1/2" x 1-1/2"
I-45 Polished Brass
I-45N Nickel Plated



Hinge used on lower doors of many Sellers cabinets. 2" Wide x 2" High in closed position. 3/8" Offset.
I-46 Polished Brass
I-46N Nickel Plated



Hinge used on inside upper doors of many Sellers cabinets. 2" Wide x 1-1/2" High fully open. 3/8" Offset.
 Short Leaf: 3/8" x 1-1/2"
 Long Leaf: 1-5/8" x 1-1/2"
I-47 Polished Brass
I-47N Nickel Plated

Hoosier Hinge



Exact replacement for butt hinge used on very early Hoosier brand cabinets. 1-3/16" High x 1-5/8" Wide. Steel.
 Short Leaf: 1-1/8" x 1/2"
 Long Leaf: 1-1/8" x 3/4"
I-31 Hoosier Hinge

Note: All hinges shown on this page are sold in pairs.

Hoosier Cabinet Hardware

Art Deco Hinges

Perfect for restoring Hoosier type cabinets made in the 1930s and 1940s. Can be used for many other applications. Available for flush or 3/8" offset doors. Solid Brass. Sold in pairs with screws.

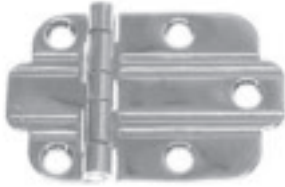

Flush mount Art Deco Hinge. Size fully open: 2-14" Wide x 1-1/2" High
I-35 Polished Brass
I-35N Nickel Plated



3/8" Offset Art Deco Hinge. Size fully open: 2-14" Wide x 1-1/2" High
I-36 Polished Brass
I-36N Nickel Plated

Hoosier Pushbutton Knob



Round pushbutton knob is similar to the knobs used on early Hoosier cabinets. Knob Diameter: 1-1/8". Projects 3/4". Oval backplate: 1-1/2" x 11/16". For doors 1/4" to 7/8" thick. Stamped brass.

KP-6 Round Pushbutton Knob



Cast brass drawer handle. Overall Size: 4-1/4" Long x 1-1/4" High. Screws on 3-3/4" centers.

P-114 Polished Brass
P-114N Nickel Plated

Drawer Pulls



Stamped brass bin pull. 3-1/2" Wide x 1-5/8" High. 3" Mounting Centers.

B-16 Polished Brass
B-16N Nickel Plated
B-16AC Antique Copper Finish



Stamped drawer pull used on early cabinets made by Wilson, Napanee and others. 3-1/2" Wide x 1" High. 2-7/8" Mounting Centers.

B-35 Polished Brass
B-35N Nickel Plated
B-35HAC Hand Aged Antique Copper



Cast brass drawer pull. 3-1/2" Long x 5/8" High. 3" Boring.

P-107 Polished Brass
P-107AB Antique Brass
P-107BN Brushed Nickel Finish
P-107N Nickel Plated
P-107HAC Hand Aged Antique Copper



Cast brass pull for kitchen cabinets. Similar to original McDougall drawer pull. 3-3/4" Long x 3/4" High. 3" Boring

P-123 Polished Brass
P-123BN Brushed Nickel
P-123N Nickel Plated



4-3/4" Long x 3/4" High. Projects 1" 4" Boring

P-124 Polished Brass
P-124N Nickel Plated

Knobs



Hoosier Knob

Knob used for the drawers of most Hoosier brand cabinets. Includes both wood and machine screws. 1-1/8" Diameter.

HBK-5 Polished Brass
HBK-5N Nickel Plated
HBK-5HAC Hand Aged Antique Copper



Oval Shaped Knob

Solid brass oval shaped knob. Ideal replacement for original knob used on many Hoosier brand roll doors. Height: 1"

HBK-7 Polished Brass
HBK-7N Nickel Plated

Sellers Glass Knobs



Glass replacement knob for Sellers kitchen cabinets. Includes nickel plated screw. 1-1/4" Diameter.

K-34C Clear Glass Knob



KSG-20 Threaded Glass Knob

Replacement for threaded glass knob used by Sellers in the early 1920s. This knob was also used by Hoosier and other cabinet manufacturers. The knob has a threaded glass shank that screws into the drawer front. Includes threaded brass insert. Knob Diameter: 1-1/4". Projects 1-3/16". Clear Glass.

KSG-20 Threaded Sellers Knob with Brass Insert
KSG-20I Brass Insert Only

Hoosier Cabinet Accessories



Hoosier Cabinet Leg

Exact replacement for the removable oak leg used on many Hoosier brand cabinets. Overall Height: 7"
HCL-5 Hoosier Cabinet Leg



Hoosier Leg Skirt

Leg skirts fits most original Hoosier cabinet legs. Also fits our **HCL-5** leg. 1-1/4" Square x 3/4" High.
HCS-5 Brass
HCS-5N Nickel Plated



Ant Trap

Replacement for the ant traps used on many Hoosier-style cabinets. Designed to fit shank of standard wood caster. Diameter: 2-3/16"
HNT-4 Brass Colored Finish
HNT-4N Nickel Plated
HNT-4S Steel



C-4

C-4B

Wood Casters

Replacements for original wood casters used on most old American furniture. Brass plated fork. **Caster sockets are not included.**
C-4 1-1/8" Dia. Wheel. Set of 4
C-4B 1-5/8" Dia. Wheel. Set of 4
C-4I Caster Socket (Sold Each)

Cookbook Holders

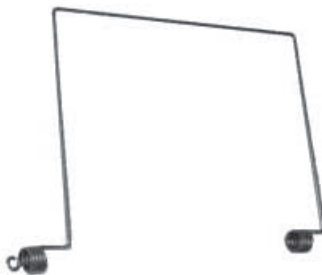

Wire cookbook holder for Hoosier and other brand cabinets. Mounts inside the upper door. 8-1/2" Wide x 5-1/2" High.

HCB-2 Cookbook Holder



Wire cookbook holder shown above with 10" Long x 5/8" Deep oak shelf. Overall Height: 5-1/2"
HCB-2W Cookbook Holder with Oak Shelf



Rolling Pin Brackets

Reproduction of original oak rolling pin brackets used on some early Hoosier cabinets like the one shown on the front cover of this catalog. Each bracket is 4-3/4" High x 3-1/4" Deep. 3/4" Thick. Sold by the pair.
RPB-2 Hoosier Rolling Pin Brackets



Carousel Spice Rack

Exact replacement for the original carousel rack used in Hoosier brand cabinets. Complete with mounting bracket. Does not include spice jars. The MSJ-1 Spice jars will fit this rack.
HSR-7 Carousel Spice Rack



Hoosier Bill Hook

Hooks used on the upper doors of Hoosier brand and other cabinets for grocery bills. 2" Long. Steel.
HBH-3 Hoosier Bill Hook

Hoosier Cabinet Accessories

Food Grinder Brackets



Hoosier Food Grinder Bracket

Exact replacement for food grinder bracket used on many Hoosier brand cabinets. Steel bracket with oak mounting block. Height: 4-1/8"

FGB-1 Hoosier Food Grinder Bracket



Sellers Food Grinder Bracket

Exact replacement food grinder bracket for Sellers brand cabinets. Includes mounting plate, bolt and wing nut. Steel bracket with oak mounting block. Height: 4-1/2"

FGB-2S Sellers Food Grinder Bracket

Sugar Jar Lid



Standard size sugar lid fits most regular size sugar jars and cracker jars. 5-1/8" Inside Diameter. Plain steel.

SJL-3 Sugar Jar Lid



Wire rack for round sugar jars used with many Hoosier style cabinets.

Inside Diameter: 6-7/8"

Height: 2-1/2"

JR-10 Sugar Jar Rack



Sellers Sugar Jar Rack

Wire rack used for Sellers sugar jar with "S" embossed on the sides.

Inside Dimensions: 6-5/8" Wide x 7-1/4" Long.

Height: 2-1/2"

JR-15 Sellers Sugar Jar Rack



Reproduction of the popular Mission pattern spice jar used in Hoosier brand cabinets. Ringed spice jar fits Hoosier carousel. Clear glass jar has metal lid with holes. Height: 4-3/8" Diameter: 2-1/8"

MSJ-1 Mission Ringed Spice Jar

Baby Pumpkin Jar



Miniature version of Colonial pattern Pumpkin jar. Clear glass made to look like old glass with bubbles and waves. The jar is 4-1/2" in diameter. Height: 4-1/2"

BPJ-2 Baby Pumpkin Jar

Colonial Pumpkin Jar



Reproduction of Colonial pattern sugar jar used by Sellers and many other cabinet manufacturers. The jar is made to resemble old glass with bubbles and waves just as Sneath did in the 1920s. The jar is 7-1/2" in diameter. Height: 7-1/2"

CPJ-1 Colonial Pumpkin Jar

Hoosier Cabinet Accessories

Coffee and Tea Jars



Reproduction Mission pattern coffee jar. Label area reads "COFFEE". Height: 8" Diameter: 4-1/4"
RCJ-3 Mission Coffee Jar



Reproduction Mission pattern tea jar. Label area reads "TEA". Height: 7" Diamete: 4-1/4"
RTJ-4 Mission Tea Jar

Mission Pattern Spice Jar



Reproduction of the popular Mission pattern spice jar used in Hoosier brand cabinets. Ringed spice jar fits Hoosier carousel. Clear glass jar has metal lid with holes. Height: 4-3/8" Diameter: 2-1/8"
MSJ-1 Mission Ringed Spice Jar

Spice Jar Lids



Pierced plated steel lid fits most Hoosier type spice jars. Inside Diameter: 1-7/8"
JL-3 Aluminum Spice Jar Lid



Aluminum lid fits many large spice jars. No holes. Inside Diameter: 2-1/2".
JL-18 Large Spice Jar Lid

Sugar Jar Lid



Standard size sugar lid fits most regular size sugar jars and cracker jars. 5-1/8" Inside Diameter. Plain steel.
SJL-3 Sugar Jar Lid

Coffee and Tea Jar Lids With Threads



Aluminum replacement lid fits most tea jars used in Hoosier type cabinets. Inside Diameter: 2-15/16"
JL-8 Tea Jar Lid



Aluminum replacement lid fits regular size coffee jars. Inside Diameter: 3-3/8"
JL-7 Regular Size Coffee Jar Lid



Aluminum replacement lid for wide mouth coffee jars. Inside Diameter: 3-7/8"
JL-6 Wide Mouth Coffee Jar Lid



Sugar Jar Dispenser Cap

Replacement dispenser cap for many swing-out type sugar jars. Diameter: 3"
SJD-6 Sugar Jar Dispenser Cap

Hoosier Cabinet Parts



Hoosier Carousel with Mission Spice Jars
 The mission carousel set includes the carousel and seven mission spice jars. Ready to install. Screws included. Overall Size: 9" Tall x 9" Diameter
MCSET-1 Carousel with 7 Mission Spice Jars

Name Plates and Labels

Reproductions of original name plates and labels used on Hoosier, Sellers, Boone, McDougall, Napanee and Wilson cabinets.

Hoosier Labels



Plastic laminated label is printed in black on white background. Similar to the original Hoosier Celluloid label. 3-1/4" Wide x 3/4" High
HL-6 Hoosier Label



Aluminum label with black print on white background. 3-3/8" Wide x 7/8" High.
HL-2 Hoosier Label



Popular Hoosier label is printed in black on brass. Label is 3-3/8" Wide x 7/8" High.
HL-3 Hoosier Label

Sellers Labels



Sellers label is printed in reverse black on brass. Label is 2-1/2" Wide x 1-1/8" High.
HSL-2 Sellers Label



Classic oval label used by Sellers in the 1920s. Reverse black on brass. 3-1/4" Wide x 1-1/8" High.
HSL-4 Sellers Label

Napanee Label



Reproduction of a label used on a 1920 Napanee kitchen cabinet. Reverse black print on brass. Label is 3-3/4" Wide x 1-1/16" High.
HNL-10 Napanee Label

McDougall Label



Reverse black printed on brass. 4-1/8" Wide x 1" High.
HML-3 McDougall Label

Boone Label



Black lettering on brass. Label is 2-1/4" Wide x 3/4" High
HBL-7 Boone Label

Wilson Label



Wilson label with reverse black on brass. 2" Wide x 3/4" High.
HWL-8 Wilson Label

Hoosier Cabinet Parts

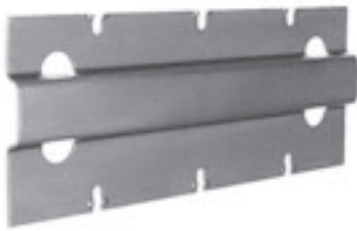

Hoosier Side Brackets

Exact replacements for original side brackets used on many Hoosier brand cabinets. Steel. 10-1/2" Long x 4-1/2" High. Side Clearance: 1/4"
HSB-1 Hoosier Side Brackets

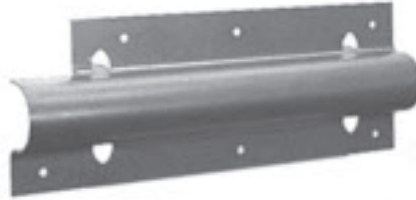

Hoosier Side Brackets

Exact replacements for some Hoosier brand cabinets. Brackets fasten to the side of both base and top units. The base unit must be the same width as the top unit. Steel. 10-5/8" Long x 3-3/4" High. Side Clearance: 3/4"
HSB-2 Hoosier Side Brackets



Cabinet Side Brackets

Exact replacement side brackets for Boone and other brand cabinets. Brackets fasten to side of both base and top units. Steel. 10-3/4" Long x 2-3/4" High. Side Clearance: 3/4"
CSB-3 Cabinet Side Brackets



Sellers Side Brackets

Exact replacements for original side brackets used on most Sellers brand cabinets. Brackets fasten to the top of the base and to the side of the top. Steel. 11" Long x 2-1/4" High. Side Clearance: 3/8"
SSB-1 Sellers Side Brackets



Cabinet Side Brackets

Side brackets used to mount cabinet top to the base unit. For Wilson and other brand cabinets. Bracket fastens to the top of the base and to the side of the cabinet top. Use these brackets for cabinets with wide porcelain tops. Steel. 11" Long x 2-3/16" High. Side Clearance: 1-7/16"
SSB-3 Cabinet Side Brackets

Recommended Mounting Screws for Side Brackets

HSB-1 #10 x 1" Round Head

HSB-2 #8 x 3/4" Round Head

HSB-3 #8 x 3/4" Round Head

SSB-1 Top: #10 x 1" Round Head
 Bottom #8 x 1" Flat Head

SSB-3 Top: #10 x 1" Round Head
 Bottom: #10 x 1-1/4" Flat Head

SC-S834R #8 x 3/4" Round Head

SC-S81F #8 x 1" Flat Head

SCS-101R #10 x 1" Round Head

SC-S10114F #10 x 1-1/4" Flat Head

Side Clearance: When the porcelain work top is wider than the cabinet base, the **Side Clearance** is the maximum additional width allowed on each side of the cabinet.

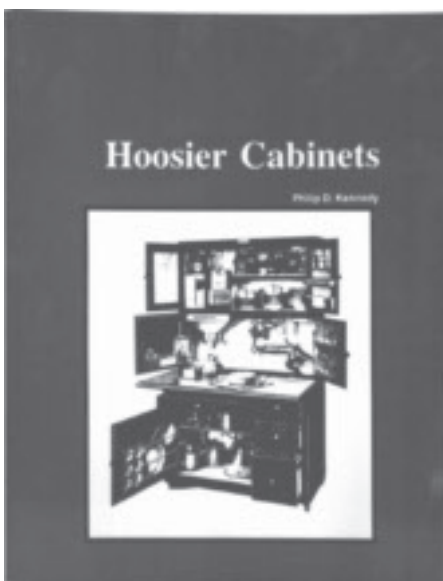

Hoosier Cabinets Book

By Philip D. Kennedy

This book is about "Hoosier Cabinets," the unique kitchen cabinets found in so many American homes from the turn of the century to the early 1930s. The book provides detailed information about Hoosier, Sellers, Napanee, Boone and McDougall kitchen cabinets and the history of the companies that made them.

The book contains many rare old magazine advertisements for kitchen cabinets that will prove invaluable when attempting to identify or date old cabinets. They also show many of the accessories and other features associated with a particular cabinet. The final section of the book includes many helpful tips and techniques used to restore old cabinets. 168 Pages, 8-1/2" X 11" Softbound.

HCB-3118 Hoosier Cabinets Book

Tambour Doors



Hoosier Roll Doors

Replacement oak roll doors for most Hoosier brand cabinets that use vertical slide type tambour doors. Completely assembled including end plates. Roll height may be trimmed to fit cabinet. Sold as set which includes both left and right door. Overall Size (Both Doors): 41" Wide x 18" High

HRT-1 Hoosier Roll Doors.



Horizontal Roll Doors

Replacement oak roll doors for Sellers, Napanee, Boone, McDougall and many other cabinets that use lift type tambour doors. Completely assembled except for base plate which must be cut to fit the opening. Base plate may be attached to roll with nails and/or glue. Roll width may be trimmed to fit the cabinet. Available in two sizes.

SRT-1 Roll Door 27-3/4" Wide x 20" High

SRT-2 Roll Door 40" Wide x 20" High

Tambour Door Hardware



Finger Cup

Brass finger cup. Ideal for Hoosier tambour doors. 1" Outside Diameter. 3/4" Bore. Depth: 1/4"

BP-75 Brass Plated
BP-75N Nickel Plated



Roll lift attaches to base plate of tambour doors.

BB-27B Solid Brass
BB-27HAC Hand Aged Copper
BB-27N Nickel Plated



Solid brass oval knob. Can be used to replace original knobs used on many Hoosier roll doors. Height: 1"

HBK-7 Brass
HBK-7N Nickel Plated



Sellers Roll Lift

Exact replacement for roll door lift used on Sellers cabinets. 3-5/16" Wide x 5/8" High. 2-3/4" Boring.

P-130B Brass
P-130HAC Hands Aged Copper
P-130N Nickel Plated



Small solid brass pull. Can be used as lift for tambour doors. 3" Long. Projects 5/8". Boring: 2-3/8"

P-103 Brass
P-103N Nickel Plated



Cast brass drawer pull. 3-1/2" Long x 5/8" High. 3" Boring.

P-107 Brass
P-107AB Antique Brass
P-107N Nickel Plated
P-107HAC Hand Aged Copper



Tambour Door Tape

100% cotton pre-shrunk twill tape. Excellent replacement backing for tambour doors. 3" Wide. Use this tape with the TG-1 Tambour Glue described below. **Sold by the foot.**

TW-3 Tambour Door Tape

Tambour Glue

A commercial-grade adhesive formulated for the furniture industry. Ideal for gluing cloth backing to tambour door slats. This multi-purpose adhesive is flexible when cured and can be used for bonding wood, leather, cloth and other porous materials. 8 Oz. Bottle.

TG-1 Tambour Glue

Hoosier Cabinet Parts

The End of an Era

The sifter bowls shown on this page represent the end of an era that lasted more than 100 years. In 1900 McCormick & Sons Hardware in Albany, Indiana began making flour bins for The Hoosier Manufacturing Co. By 1910 Hoosier had become so large that they began making their own flour bins. However, McCormick continued to make flour bins for other cabinet manufacturers.

In 1972 McCormick sold their business to Feeny Manufacturing in nearby Muncie, Indiana. Feeny continued manufacturing flour bins until 1986. In 1989 Kennedy Hardware bought the remaining McCormick dies, fixtures, tools and machines from Feeny and we began making flour bins again in 1990.

In the fall of 2013 we decided to discontinue the manufacturing of flour bins due to the declining condition of the dies and machines (most were over 90 years old). We assembled our last flour bins and sifter bowls in the late spring of 2014. Those flour bins are all gone. We still have some sifter bowls and sifter bowl components. When the current stock of these items has been sold there will be no more.



Hoosier Flour Bin Eye Bolt

Replacement eye bolt to mount Hoosier sifter head to flour bin.

MHB-1 Eye Bolt with Brass Nut

MHN-2 Knurled Brass Nut Only

Replacement Sifter Bowl

Replacement sifter bowl for most McCormick flour bins. These sifter bowls are manufactured in our shop using the original McCormick dies and fixtures. Complete assembly includes bowl, sifter screen, wire sifter reel, crank, sifter cap and mounting pins. 5-1/4" Diameter.

SFH-5 Replacement Sifter Bowl

Replacement Parts for SFH-5 Sifter Bowl

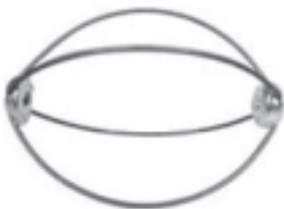

SFR-9 Sifter Reel

Steel wipers with molded hubs.

Length: 4-1/2"



SFC-6 Sifter Crank

Steel rod with threaded end. With white wood knob. 7-1/2" Long

Hoosier Cabinet Parts

Replacement Bread Drawers

Tin replacement bread drawers for Hoosier, Sellers, McDougall, Boone, Wilson and other cabinets. Carefully check the size of your original drawer before ordering. The width is the most critical dimension. Predrilled front edges nail to the original wood drawer front. **NOTE:** In some cases it may be necessary to cut and bend lower front edge down at a right angle to accommodate original drawer front. **All drawers include sliding lid.**

Hoosier Bread Drawers



Drawer fits many original Hoosier brand cabinets. Size: 7-5/8" High x 10-7/8" Wide x 19-5/8" Long.
HBD-1 Hoosier Bread Drawer

Replacement for the deeper bread drawer used in some Hoosier brand cabinets. Size: 9-5/8" High x 10-7/8" Wide x 19-5/8" Long.

HBD-5 Hoosier Bread Drawer



Replacement for the shallow center drawer used for pies or pastries in some Hoosier brand cabinets. Size: 4-1/2" High x 10-7/8" Wide x 19-5/8" Long.

HBD-7 Hoosier Pastry Drawer

McDougall Bread Drawer



Replacement bread drawer fits many McDougall brand cabinets. Size: 8-7/8" High x 11-13/16" Wide x 19-5/8" Long. Includes 7/8" High x 3/8" Deep channels for drawer guides.

HBD-3 McDougall Bread Drawer

Sellers Bread Drawers



Replacement bread drawer fits many Sellers brand cabinets. Size: 7-1/8" High x 11-1/4" Wide x 17-1/2" Long. Includes 7/8" High x 3/8" Deep channels for drawer guides.

HBD-2 Sellers Bread Drawer



Replacement for bread drawer used on some older Sellers cabinets. Size: 8-1/2" High x 11-1/4" Wide x 19" Long. Includes 7/8" High x 3/8" Deep channels for drawer guides.

HBD-6 Sellers Bread Drawer

Wilson Bread Drawer



Bread drawer fits Boone, Wilson and other cabinets. Size: 9" High x 13-3/4" Wide x 19" Long.

HBD-4 Wilson Bread Drawer

Replacement Bread Drawer Lids



Replacement lids for bread drawers shown here will fit some original bread drawers. Rolled edge is 5/16" High. Check measurements of your bread drawer before ordering. **NOTE: All bread drawers shown on this page are furnished with lids.**

HBD-1L Bread Drawer Lid
19-1/4" Long x 10-3/4" Wide

HBD-2L Bread Drawer Lid
17-1/8" Long x 11-1/8" Wide

HBD-3L Bread Drawer Lid
19-1/4" Long x 11-5/8" Wide

HBD-4L Bread Drawer Lid
18-3/4" Long x 13-11/16" Wide

HBD-6L Bread Drawer Lid
18-5/8" Long x 11-1/8" Wide

HBD-11L Bread drawer lid designed to replace original bread drawer lid on many Hoosier brand cabinets. Lid has triple-folded edge to fit narrow channel of original Hoosier bread drawers.
19-1/4" Long x 10-3/4" Wide

Custom Bread Drawers

We are now able to provide custom size bread drawers and bread drawer liners. They are made on the same machines as our standard bread drawers.

Bread drawer liners are available only in stainless steel.

Please call for prices and how to determine proper measurements for a custom drawer or liner. Allow three to four weeks for delivery.

Custom bread drawers and liners are not returnable.

Hoosier Cabinet Accessories



Hoosier Door Chart Set

Exact copies of original door charts used on many old Hoosier brand cabinets. Printed in black ink with light blue vertical trim on beige card stock. Food timer chart includes brass pointers just like the original. Set includes three door charts: one chart is 8-1/2" Wide x 15" High and the other two are 7-5/8" Wide and 15" High.

HDC-1 Hoosier Door Chart Set



Sellers Door Chart Set

Exact copies of the original door charts used on many Sellers brand cabinets. Printed in black ink with olive green borders on beige card stock. Each chart is 8" Wide x 15" High. Set includes three charts.

SDC-1 Sellers Door Chart Set



McDougall Door Chart Set

Exact copies of original door charts used on many McDougall brand cabinets. Printed in blue and black ink on beige card stock with blue and gray trim. Each chart is 8-5/16" Wide x 12" High. Set includes three charts.

MDC-1 McDougall Door Chart Set



Sellers 6-Piece Door Chart Set

Six-piece Sellers Door Chart set. Two of the door charts measure 14-1/2" High x 7-1/4" Wide. The other four charts measure 8-3/4" High x 7-1/4" Wide. These door charts were used in the 48-inch Mastercraft cabinets in the early 1920s. The four charts in the center can be used in other cabinets. Black print on cream card stock with light green borders.

SDC-2 Sellers Six-Piece Door Chart Set

1921 Hoosier Cabinet Kits

These kits are used with the 1921 Hoosier Cabinet Plans shown on Page 20

Basic Hoosier Cabinet Kit

The Basic Kit includes all of authentic Hoosier Hardware needed to build the cabinet. The Basic Kit includes the following items:

- 1 Set of C-4 Wood Casters
- 4 C-4I Caster Inserts
- 4 HCL-5 Oak Hoosier Cabinet Legs
- 4 HCS-5 Brass L eg Skirts
- 4 HNT-4 Brass Finish Ant Traps
- 1 Pair HRT-1 Oak Tambour Doors
- 3 Pair I-33 Hoosier Hinges for Upper Doors
- 1 Pair I-34 Hoosier Hinges for Lower Door
- 3 I-23 Hoosier "H" Latches
- 4 HBK-5 Hoosier Drawer Knobs
- 2 HBK-7 Tambour Door Knobs
- 1 Pair HSB-2 Hoosier Side Brackets
- 1 BP-93 Elbow Catch
- 1 HL-3 Hoosier Name Plate
- 1 Pkg 8 Shelf Rests
- 1HBD-1 Tin Bread Drawer

HCBK-1 Hoosier Basic Kit with Brass Hardware

HCBK-2 Hoosier Basic Kit with Nickel Plated Hardware

NOTE: When the kit is ordered with nickel plated hardware the HL-2 white aluminum label is substituted for HL- 3 brass Hoosier label.



Bread Drawer



Tambour Doors



Side Brackets



Hoosier Legs

Hoosier Hardware

Hoosier Cabinet Accessory Kit

The Hoosier Cabinet Accessory Kit contains the following items:

- 1 Set Hoosier Door Charts
- 1 HCB-2 Cook Book Holder
- 1 HSR-7 Hoosier Carousel Spice Jar Rack
- 7 MSJ-1 Hoosier Mission Spice Jars

HCAK-1 Hoosier Accessory Kit



Mission Spice Jars



Carousel Rack



Door Charts



Cook Book Holder

1921 Hoosier Cabinet Plans



Complete set of plans for a 1921 Hoosier cabinet. Includes CAD generated detail drawings and an instruction booklet.

HCP-1 Hoosier Cabinet Plans

We offer complete hardware and accessory kits for this project.

NOTE: This project requires considerable wood-working skill and knowledge.

Pie Safe Plans



In the early 1900s large handsome cupboards like this could be found stocked with warm pies and fresh baked bread. This pie safe will fit in any room where extra storage space is needed. Our pie safe has three shelves and two drawers at the top.

The well detailed instructions include directions for punching the pie safe tins or we can provide pre-punched tins.

Size: 36" High x 32" Wide x 21" Deep

PSP-1 Pie Safe Plans

Ice Box Plans



The oak country ice box was once found in kitchens all over America. This reproduction of an old ice box can be used for storage, a bar, a stereo or just an interesting piece of furniture.

The hardware for this project can be found on the next page.

IBP-1 Ice Box Plans

Ice Box Hardware



Left

Right

Ice Box Latches

Cast brass ice box latches. 3/8" Offset. Overall Length: 4-1/4". Latch Base: 2-1/4" High x 1-1/16" Wide.

Catch Base: 2-1/4" High x 7/8" Wide.

- IB-30** Left Door Polished Brass
- IB-30AB** Left Door Antique Brass
- IB-30N** Left Door Nickel Plated
- IB-31** Right Door Polished Brass
- IB-31AB** Right Door Antique Brass
- IB-31N** Right Door Nickel Plated



Ice Box Hinges

Cast brass ice box hinges. 3/8" Offset. Hinge is 3-1/2" Long x 1-7/8" High. Sold in pairs.

- IB-22** Ice Box Hinges Polished Brass
- IB-22AB** Ice Box Hinges Antique Brass
- IB-22N** Ice Box Hinges Nickel Plated



White Clad Ice Box Label

Cast Brass. 3-9/16" Long x 1-9/16" High

- IB-10** Ice Box Label Brass
- IB-10AB** Ice Box Label Antique Brass
- IB-10N** Ice Box Label Nickel Plated



New Columbia Ice Box Label

Cast Brass. 5" Long x 1-1/8" High

- IB-12** Ice Box Label Brass
- IB-12N** Ice Box Label Nickel Plated



Ice Box Hinges

Heavy wrought brass. 3/8" Offset. Hinge is 4" Long x 1-1/2" High. Sold in pairs.

- I-8** Ice Box Hinges Brass
- I-8N** Ice Box Hinges Nickel Plated



BI-51 Cast Brass Ice Box Door Lift

3-5/8" Long x 7/16" High 2-7/8" Boring



Antique Bottle Opener

An authentic reproduction of the classic bottle opener. 3" High x 2-1/2" Wide

- IB-15** Bottle Opener Polished Brass
- IB-15AB** Bottle Opener Antique Brass

Ice Box Hardware Kit

This kit contains the hardware to build the replica Ice Box shown on Page 20.

- IBK-1** Ice Box Kit Polished Brass
- IBK-1AB** Ice Box Kit Antique Brass
- IBK-1N** Ice Box Kit Nickel Plated



Ice Box Latches



Ice Box Label



Ice Box Hinges

Drawer Pulls



B-1MA Small Bail Pull
Stamped Brass, Matches B-1
2" Boring



Bail Pull
Stamped Brass, 3" Boring
B-1 Polished Brass
B-1AB Antiques Brass



Bail Pull
Stamped Brass, 3" Boring
B-2 Polished Brass
B-2AB Antique Brass



B-3 Bail Pull
Stamped Brass, 3" Boring



B-18 Cast Brass Bail Pull
Stamped Washers, Turned Posts
2" Boring



Victorian Bail Pull
Cast Brass, 3" Boring
B-7 Polished Brass
B-7AB Antique Brass



Victorian Bail Pull
Cast Brass, 3" Boring
B-14 Polished Brass
B-14AB Antique Brass



G-14 Bail Pull
Cast Brass, Dull Brass Color
3" Boring



B-17 Bail Pull
Cast Brass, 3" Boring



B-8 Series Cast Brass Bails
Period style "swan neck" bails with
turned posts. Precision cast bail and
1" diameter stamped backplates.
B-8A 2-1/2" Boring, Polished Brass
B-8AAB 2-1/2" Boring, Antique Brass

B-8B 3" Boring, Polished Brass
B-8BAB 3" Boring, Antique Brass

B-8C 3-1/2" Boring, Polished Brass
B-8CAB 3-1/2" Boring, Antique Brass



B-9 Series Cast Brass Bails
Period style "swan neck" bails with
turned posts. Precision cast bails and
1" stamped backplates.
B-9A 2-1/2" Boring
B-9 3" Boring
B-9B 3-1/2" Boring



B-8D "Swan Neck" Bail Pull
Cast Brass, 1-3/16" Backplates
4" Boring



Bail Pull
Stamped Brass, 3" Boring
BP-5 Polished Brass
BP-5AB Antique Brass

Drawer Pulls

Stamped Brass Backplates



P-1M Small Drawer Pull
Backplate: 2-3/4" W x 1-1/4" H
2" Boring, Matches P-1



Victorian Drawer Pull
Backplate: 4-1/8" W x 1-7/8" H
3" Boring
P-1 Polished Brass
P-1AB Antique Brass



P-3 Victorian Drawer Pull
Backplate: 4-1/8" W x 1-3/4" H
3" Boring



Victorian Drawer Pull
Backplate: 4-1/2" W x 2-1/4" H
3" Boring
P-26 Polished Brass
P-26AB Antique Brass

Stamped Brass Backplates



Victorian Drawer Pull
Backplate: 4-3/4" W x 2-1/4" H
3" Boring
P-27 Polished Brass
P-27AB Antique Brass



P-29 Eastlake Drawer Pull
Backplate: 4-1/8" W x 1-7/8" H
3" Boring



P-30 Eastlake Drawer Pull
Backplate: 5" W x 1-3/4" H
3" Boring



BP-7 Drawer Pull
Backplate: 4-7/8" W x 1-7/8" H
3" Boring

Stamped Brass Backplates



Drawer Pull
Backplate: 4-3/4" W x 1-5/8" H
3" Boring
BP-8 Polished Brass
BP-8HAB Hand Aged Brass



PS-6 Drawer Pull
Backplate: 4-1/8" W x 1-3/4" H
3" Boring



PS-18 Drawer Pull
Backplate: 3-5/8" W x 1-3/4" H
3" Boring



P-28 Victorian Drawer Pull
Backplate: 5-7/8" W x 2-3/4" H
Cast Brass Posts
3" Boring

Drawer Pulls

Cast Brass Backplates



P-2AB Cast Brass Drawer Pull
Antique Brass Finish
Backplate: 3-3/4" W x 1-7/8" H
3" Boring



Cast Brass Drawer Pull
Backplate: 3-7/8" W x 1-7/8" H
3" Boring
P-11 Polished Brass
P-11AB Antique Brass



P-22 Cast Brass Drawer Pull
Backplate: 4-3/8" W x 1-7/8" H
Boring: 3"



G-32 Cast Brass Drawer Pull
Backplate: 4-1/2" W x 2-1/4" H
Boring: 3"

Cast Brass Backplates



P-31 Cast Brass Drawer Pull
Backplate: 3-3/4" W x 2" H
Boring: 3"



Cast Brass Drawer Pull
Backplate: 4-1/4" W x 2" H
3" Boring
P-34 Polished Brass
P-34AB Antique Brass

Mission Style Pulls



3-3/4" Long x 3/4" High.
Projects 1" 3" Boring
P-123 Polished Brass
P-123BN Brushed Nickel
P-123N Nickel Plated



4-1/8" Long x 3/4" High.
Projects 1" 3-1/2" Boring
P-148 Polished Brass
P-148N Nickel Plated



4-3/4" Long x 3/4" High.
Projects 1" 4" Boring
P-124 Polished Brass
P-124N Nickel Plated

Hepplewhite Handles

Cast bails with turned posts.
Stamped brass backplates.



Backplate: 2-1/2" W x 1-3/4" H
2" Boring
P-21H Polished Brass
P-21HAB Antique Brass



Backplate: 3" W x 2-3/8" H
2-1/2" Boring
P-21A Polished Brass
P-21AAB Antique Brass



Backplate: 3-3/4" W x 2-3/4" H
3" Boring
P-21C Polished Brass
P-21CAB Antique Brass

Colonial Revival Pull



Stamped Brass
Center Mounted
3" W x 1-5/8" H
D-66 Polished Brass
D-66AB Antique Brass

Tear Drop Pulls



D-2A 1-1/2" Drop, Backplate: 1" Dia



D-2B 2" Drop, Backplate: 1-1/4" Dia

Pulls



BI-59AB Ornate Victorian Pull
For drawers or cabinet doors. Cast Brass. Antique Brass Finish. 3-7/8" Long x 5/8" Wide. 3-1/8" Boring



BI-51 Cast Brass Ice Box Door Lift
3-5/8" Long x 7/16" High
2-7/8" Boring



P-105CI Cast Iron Drawer Pull
Cast iron drawer pull can be used for many applications. 3-1/2" Wide x 7/16" High. 3" Boring

Chippendale Handles

Cast bails with turned posts.
Stamped brass backplates.



P-60B Chippendale Handle Set
Backplate: 3-1/8" W x 2-1/2" H
2-1/2" Boring



P-60BE Chippendale Keyhole
Matches P-60B Handle
3-1/8" W x 2-1/2" H



P-60A Chippendale Handle Set
Backplate: 4" W x 3-1/8" H
3" Boring

Drawer Pull With Pierced Backplates



B-15 Cast Brass Drawer Pull
Backplates: 1-1/8" W x 1-1/2" H
3" Boring

Eastlake Hardware



Stamped Brass Eastlake Pull
Backplate: 4-1/4" W x 1-1/2" H
3" Boring

D-55 Polished Brass
D-55N Nickel Plated

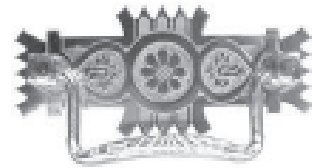

Stamped Brass Eastlake Pull
Backplate: 3-1/4" W x 1-1/2" H
2-1/2" Boring

D-56 Polished Brass
D-56N Nickel Plated



D-57 Eastlake Ring Pull
Stamped Brass
Plate: 1-1/2" W x 1-3/4" H
Ring Diameter: 1-3/4"



E-58 Eastlake Keyhole
Stamped Brass
1" W x 1-1/2" H

Period Hardware

Victorian Drops



D-5AA Victorian Drop
Drop: 1-7/16" x 7/8"
Backplate Dia: 1-1/4"



D-5 Victorian Drop
Drop : 2" x 1-3/16"
Backplate Dia: 1-5/8"



D-306 Victorian Drop
Drop: 3-1/8" x 1-3/16"
Backplate Dia: 1-1/2"

Victorian Knobs



1" Diameter
Projects: 1-5/16"
K-11B Ebony
K-12 Walnut



K-68 Ebony Victorian Knob
1-1/2" Diameter
Projects: 1-1/4"

Colonial Revival and Depression Era Pulls



Drawer Pull
Stamped Brass
Center Mounted
3" W x 1-5/8" H
D-66 Polished Brass
D-66AB Antique Brass



D-69 Drawer Pull
Stamped Brass
Center Mounted
2-3/4" W x 2-1/8" H



Drawer Pull
Stamped Brass
Center Mounted
2-1/8" W x 2-1/4" H
D-95 Polished Brass
D-95AB Antique Brass



D-94 Drawer Pull
Stamped Brass
Center Mounted
2-1/2" W x 1-3/8" H



D-65AB Drawer Pull
Stamped Antique Brass
Center Mounted
2-3/4" W x 2-1/8" H



D-67 Ring Pull
Stamped Brass
Center Mounted
2" Diameter



Ring Pull
Stamped Brass
Center Mounted
1-5/8" Diameter
D-68 Polished Brass
D-68AB Antique Brass



D-80 Drop Pull
Cast Brass
Drop: 1-3/4" x 1-1/4" W
Backplate: 1-3/16" Dia.



D-81 Drop Pull
Cast Brass
Drop: 2" x 1-1/2" W
Backplate: 1-1/2" Dia.

Waterfall Hardware

The Waterfall pulls and knob shown below have been reproduced from actual hardware used on Waterfall furniture from the 1930s and 1940s. They are made from die cast zinc and plastic resin just like the originals



WF-100 Waterfall Pull
5-1/2" Wide x 2-3/4" High
Mounting Centers: 3-1/2"



WF-101 Waterfall Pull
6" Wide x 1-5/8" High
Mounting Centers: 4-1/4"



WF-102 Waterfall Pull
4-3/4" Wide x 3" High
Mounting Centers: 4"



WF-103 Waterfall Pull
5-1/8" Wide x 2-1/4" High
Mounting Centers: 4-1/2"



WF-104 Waterfall Knob
2" Diameter
Projects: 3/4"

To see this Waterfall hardware
in color visit our web site at:
www.kennedyhardware.com

Art Deco Hinges

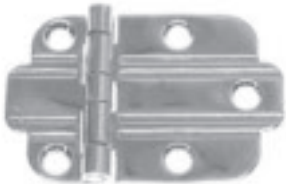

Flush mount Art Deco Hinge. Size
fully open: 2-14" Wide x 1-1/2" High
Sold in Pairs

- I-35** Polished Brass
- I-35BN** Brushed Nickel
- I-35N** Nickel Plated
- I-35ORB** Oil Rubbed Bronze



3/8" Offset Art Deco Hinge. Size fully
open: 2-14" Wide x 1-1/2" High
Sold in Pairs

- I-36** Polished Brass
- I-36BN** Brushed Nickel
- I-36N** Nickel Plated
- I-36ORB** Oil Rubbed Bronze

Art Deco Hardware

Art Deco Pulls



3" Mounting Centers
3-3/4" Wide x 1" High
DA-31 Polished Brass
DA-31N Polished Nickel



4-1/2" Mounting Centers
5-1/16" Wide x 1" High
DA-34 Polished Brass
DA-34N Polished Nickel



4" Wide x 7/8" High
3-1/2" Mounting Centers
DA-32 Polished Brass
DA-32N Polished Nickel

Art Deco Knobs

These elegant solid brass knobs are
available in polished brass or bright
nickel. They can be used on Art Deco
furniture or modern cabinets



1-1/2" x 7/8", Projects 7/8"
KA-36 Polished Brass
KA-36N Polished Nickel



1-3/16" Diam., Projects 1-1/8"
KA-37 Polished Brass
KA-37N Polished Nickel

Mission Hardware

Mission Style Pulls



Die Cast Zinc, 3-3/4" W x 2" H
3" Mounting Centers
PM-201 Antique Brass
PM-221 Black



Die Cast Zinc, 2-3/4" W x 1-3/4" H
1-1/8" Vertical Mounting Centers
PM-202 Antique Brass
PM-222 Black



Die Cast Zinc, 3-3/4" H x 1" W
2-1/4" Vertical Mounting Centers
PM-203 Antique Brass
PM-223 Black

Cast Brass Mission Handles



3-3/4" Long x 3/4" High.
Projects 1" 3" Boring
P-123 Polished Brass
P-123BN Brushed Nickel
P-123N Nickel Plated



4-3/4" Long x 3/4" High.
Projects 1" 4" Boring
P-124 Polished Brass
P-124N Nickel Plated

Brass Mission Knobs

Cast brass Mission/Arts & Crafts pyramid knobs available in three sizes.



K-61 3/4" Square, Projects 3/4"



K-62 1" Square, Projects 7/8"



K-63 1-1/4" Square, Projects 1"

Antique Copper Mission Knob



Cast brass mission pyramid knobs with antique copper finish.
1" Square, Projects 7/8"
K-62AC Antique Copper

Cast Iron Mission Knob



K-62CI Cast Iron Knob
1" Square, Projects 7/8"

Mission Pulls with Antique Copper Finish



Die cast zinc with antique copper finish. 3-1/2" H x 1-3/4" W
2-1/4" Vertical Mounting Centers
PM-502 Antique Copper

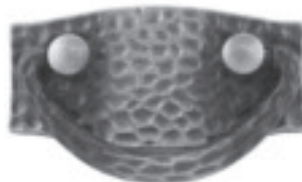

Die cast zinc with antique copper finish. 2-1/16" H x 3-1/2" W
3" Horizontal Mounting Centers
PM-503 Antique Copper

Oak Mission Knobs



O-15 Pyramidal Oak Knob
1-1/4" Square, Projects 7/8"



O-16 Pyramidal Oak Knob
1-3/4" Square, Projects 1-1/8"

Oak Mission Handle



O-17 Oak Pyramidal Handle
Solid oak mission style pyramidal handle. 4-1/2" Long x 1-1/2" High
Projects 1-1/8"

Handles and Pulls



E-12R Door Handle
3-3/4" H x 3/4" W
With Keyhole
Cast Brass



E-13 Door Handle
3-1/4" H x 3/4" W
Cast Brass



EP-7 Push Button Latch
Handle is 3-3/8" High x 3/4" Wide. Will fit doors from 1/2" to 1" thick. Solid brass handle and push button.

Flush Ring Pull



P-112 Flush Pull
Solid brass flush mount ring pull. Includes screws. 1-7/16" Wide x 1-3/4" High.

Drop Pulls



E-14B Pull
Cast brass pull with keyhole. 2-1/2" x 1-5/8"



E-15B Pull
Cast Brass
2-1/2" x 1-5/8"



E-214 Pull
Cast brass pull with keyhole. 2" x 1-9/16"



D-80 Drop Pull
Cast Brass
Drop: 1-3/4" x 1-1/4" W
Backplate: 1-3/16" Dia.



D-912 Drop Pull
Cast Brass
2-3/8" W x 2-3/4" H



D-59 Brass Ring Pull
Backplate: 2" x 2"
Ring: 1-5/8" Dia.



D-1A Brass Ring Pull
Backplate: 1-3/4" Dia.
Ring: 1-3/4" Dia.



D-81 Drop Pull
Cast Brass
Drop: 2" x 1-1/2" W
Backplate: 1-1/2" Dia.



Cast Brass Lion Head Pull
Backplate: 1-5/8" W x 2" H
Ring: 1-1/2" Dia.
D-205 Polished Brass
D-205AB Antique Brass



D-50 Bow Pull
Solid Brass
Backplate: 1-1/8" Dia.
1-1/2" Wide



D-51 Bow Pull
Solid Brass
1" Wide



D-88 Drop Pull
Cast Brass
Drop: 2" x 1-1/2" W
Backplate: 2-1/4" x 1-1/8"

Knobs

Small Brass Knobs

Solid brass knobs supplied with machine screw and wood screw. For bookcases and other applications.



- K-3A** 3/8" Diameter Brass, Projects 7/16"
- K-3B** 1/2" Diameter Brass, Projects 1/2"
- K-3BN** 1/2" Diameter Nickel Plated, Projects 1/2"
- BK-3C** 5/8" Diameter Brass, Projects 1/2"
- BK-3D** 3/4" Diameter Brass, Projects 9/16"

Solid Brass Turned Knobs

With stamped brass backplates. Supplied with both machine screw and wood screw. Polished Brass. Backplates same diameter as knob.



- K-4M** 5/8" Diameter, Projects 5/8"
- K-4** 3/4" Diameter, Projects 3/4"
- K-4A** 1" Diameter, Projects 1"
- K-4B** 1-1/4" Diameter, Projects 1-1/4"

Colonial Revival Brass Knob



K-46 Brass Knob
1" Diameter
Projects 1"

Oval Knobs

Solid Brass
1" x 5/8", Projects 1"



HBK-7 Brass
HBK-7N Nickel Plated

Period Style Knobs

Hollow stamped brass knobs with stamped brass backplates.



K-6A
1" Diameter
Projects 5/8"



K-6B
1-1/4" Diameter
Projects 13/16"

Ornate Cast Brass Knobs

Ideal for American oak furniture from the early 1900s. Supplied with stamped brass backplates.



K-1A
1-1/8" Diameter
Projects 7/8"



K-1B
1-1/2" Diameter
Projects 1"



1-1/4" Diameter
Projects 7/8
K-8 Polished Brass
K-8AB Antique Brass



K-9
1-3/16" Diameter
Projects 7/8



K-10B
1-1/2" Diameter
Projects 7/8

Machined Brass Knobs

Supplied with machine screw and wood screw.



K-26
5/8" Diameter
Projects 1/2"



K-28
7/8" Diameter
Projects 1/2"

Decorator Knobs



Brass knob with turned base. 1-1/4" Diameter, Projects 1-1/8"
K-38 Nickel Plated
K-38BN Brushed Nickel
K-38ORB Oil Rubbed Bronze

Solid brass knobs available in brushed nickel or oil rubbed bronze. Mounts with machine screw. 1-1/4" Diameter. Projects 1". Base diameter is 11/16".



K-24BN Brushed Nickel
K-24ORB Oil Rubbed Bronze

Art Deco Knobs

These elegant solid brass knobs are available in polished brass or bright nickel. They can be used on Art Deco furniture or modern cabinets



1-1/2" x 7/8", Projects 7/8"
KA-36 Polished Brass
KA-36N Polished Nickel



1-3/16" Diam., Projects 1-1/8"
KA-37 Polished Brass
KA-37N Polished Nickel

Cast Brass Mission Knobs



K-61 3/4" Square, Projects 3/4"



K-62 1" Square, Projects 7/8"



K-63 1-1/4" Square, Projects 1"

Antique Copper Mission Knob



Cast brass mission pyramid knobs with antique copper finish. 1" Square, Projects 7/8"
K-62AC Antique Copper

Cast Iron Knobs



K-16CI Cast Iron Knob
 Cast iron knob with scroll design on the face. Matches BB-16CI cast iron bin pull shown on Page 2. 1" Diameter, Projects 15/16"



K-5CI Cast Iron Knob
 Cast iron cabinet knob is painted black and with machine screw. 1-3/16" Diameter. Projects 1-3/16". Base diameter is 5/8".



K-62CI Cast Iron Mission Knob
 1" Square, Projects 7/8"



Solid Brass Mock Key
 1-7/16" H x 1/2" W
E-905B Polished Brass
E-905AB Antique Brass

Spool Cabinet Knob



BK-18 Stamped Brass Spool Cabinet Knob
 Knob Diameter: 1-3/8", Projects 1-1/8"
 Backplate: 1-1/8"

Wood Knobs

Cherry Knobs



C-10
1-1/4" Diameter
Projects 15/16"



C-11
1-1/2" Diameter
Projects 1"



C-12
1-3/4" Diameter
Projects 1-1/8"



C-13
2" Diameter
Projects 1-3/16"

Walnut Knobs



W-10
1-1/4" Diameter
Projects 15/16"



W-11
1-1/2" Diameter
Projects 1"



W-12
1-3/4" Diameter
Projects 1-1/8"



W-13
2" Diameter
Projects 1-3/16"

Oak Knobs



O-9
1" Diameter
Projects 7/8"



O-10
1-1/4" Diameter
Projects 7/8"



O-11
1-1/2" Diameter
Projects 7/8"



O-12
1-3/4" Diameter
Projects 7/8"



O-13
2" Diameter
Projects 1"



W-12TH Threaded Walnut Knob
Walnut knob drilled and tapped for 1/2" Dia. x 1-1/2" Long threaded dowel which is included. Knob Diameter: 1-3/4"



W-18 Turned Walnut Knob
2" Diameter, Base Diameter: 1-3/8"
Projects 1-1/8"

Square Oak Knobs

Ideal knobs for oak Mission style furniture



O-15
1-1/4" Square
Projects 7/8"



O-16
1-3/4" Square
Projects 1-1/8"

Other Wood Knobs



WK-8
Hardwood Knob
3/4" Diameter
Projects 5/8"



Victorian Knobs
K-11B Ebony 1" Diameter
K-12 Walnut 1" Diameter
Both knobs project 1-5/16"



Push Button Latches, Cupboard Turns, and Cabinet Pulls

Push Button Latches



EP-7 Push Button Latch
 Push button latch can be used for many applications. Handle is 3-3/8" High x 3/4" Wide. Will fit doors from 1/2" to 1" thick. Solid brass handle and push button.

Push Button Knobs



KP-5 Push Button Knob
 This unique solid brass knob includes a push button latch. Knob mounts to door with two screws. Can be used for doors 1/4" to 3/4" thick. Knob Base: 1-3/16" x 1-5/16" Projects 13/16"



KP-6 Push Button Knob
 Round pushbutton knob is similar to the knobs used on early Hoosier cabinets. Stamped brass. Can be used on doors 1/4" to 3/4" Thick. Knob Diameter: 1-1/8" Oval Backplate: 1-1/2" x 11/16" Projects 3/4"

Cupboard Turns



K-7A Cupboard Turn
 1" cast brass knob. 8-32 threaded shaft with cast brass latch finger.



K-7B Cupboard Turn
 1-1/4" brass knob. 8-32 threaded shaft with cast brass latch finger.



D-10S Latch Finger
 Cast brass latch finger for cupboard turns. 8-32 x 2-3/4" threaded shaft with 1-3/8" x 3/8" cast brass latch finger.

Spindle Cabinet Pulls

High quality brass spindle pulls.



Small Cabinet Pull
 Overall Length: 4-3/4", Boring: 3"
P-425 Polished Brass
P-425N Nickel Plated



Large Cabinet Pull
 Overall Length: 6-3/4", Boring: 5"
P-426 Polished Brass
P-426N Nickel Plated

Porcelain and Glass Knobs

Porcelain Knobs

Basic white porcelain knobs.
Brass plated screws included.



PK-10
1/2" Diameter
Projects 9/16"



PK-11
3/4" Diameter
Projects 5/8"



PK-12
1" Diameter
Projects 7/8"



PK-13
1-1/4" Diameter
Projects 1"



PK-14
1-1/2" Diameter
Projects 1-1/4"

Fluted Glass Knobs

Clear glass knobs with unique
fluted design. Nickel plated screw
included.



K-74B 1" Diameter



K-74C 1-1/4" Diameter



K-74D 1-1/2" Diameter

Threaded Glass Knob



Replacement for threaded glass
knob used by Sellers, Hoosier and
other cabinet manufacturers. The
knob has a threaded glass shank
that screws into the drawer front.
Includes brass insert. Clear
Glass.

Knob Diameter: 1-1/4"
Projects 1-3/16"

KSG-20 Threaded Glass Knob
with Brass Insert
KSG-20I Insert Only

Pressed Glass Knobs

Late Victorian glass knobs made by
hand pressing with antique glass
making equipment.



KG-38 Pressed Glass Knob
Pressed glass knob with 8-32 threaded
insert inside the base of the knob.
Top Diameter: 1-3/4"
Base Diameter: 1-3/8"
Projects 1-3/8"

Empire Style Glass Knobs



Clear Pressed Glass
Mount with Threaded Stem and Nut

KG-42 Pressed Glass Knob
1-1/2" Diameter, Projects 1-1/4"
Base Diameter: 1-1/4"

KG-44 Pressed Glass Knob
2-1/8" Diameter, Projects 1-1/2"
Base Diameter: 1-9/16"

Glass Knobs and Handles

Glass Knobs

Replacements for glass knobs used on old Hoosier type cabinets and other furniture. Nickel plated screw included.



1" Diameter, Projects 1"

- K-32B** Milk White
- K-33B** Black
- K-34B** Clear
- K-35B** Cobalt Blue
- K-36B** Ruby Red
- K-37B** Depression Green
- K-41B** Peacock Blue
- K-42B** Amethyst
- K-43B** Depression Pink
- K-44B** Amber
- K-47B** Milk Blue (Delphite)
- K-48B** Milk Green (Jadite)



1-1/2" Diameter, Projects 1-1/2"

- K-32D** Milk White
- K-33D** Black
- K-34D** Clear
- K-35D** Cobalt Blue
- K-36D** Ruby Red
- K-37D** Depression Green
- K-41D** Peacock Blue
- K-42D** Amethyst
- K-43D** Depression Pink
- K-44D** Amber
- K-47D** Milk Blue (Delphite)
- K-48D** Milk Green (Jadite)



1-1/4" Diameter, Projects 1-1/4"

- K-32C** Milk White
- K-33C** Black
- K-34C** Clear
- K-35C** Cobalt Blue
- K-36C** Ruby Red
- K-37C** Depression Green
- K-41C** Peacock Blue
- K-42C** Amethyst
- K-43C** Depression Pink
- K-44C** Amber
- K-47C** Milk Blue (Delphite)
- K-48C** Milk Green (Jadite)



K-34E Clear Glass Knob
1-3/4" Diameter, Projects 1-11/16"

To see these glass knobs and handles in color go to our web site at: www.kennedyhardware.com

Post Screw for Glass Knobs and Handles



Special pan head post screw for mounting 1-1/4" glass knobs and 3" glass handles. Use these post screws for a flush screw mount inside a drawer or door. Eliminates the bolt and nut sticking out inside the drawer or door. Sold each.
K-96CS Nickel Plated Post Screw



Special pan head screw for glass knobs and handles. No slot in head. 2-1/2" Long. 8-32 Thread.
K-34SB Brass Plated
K-34SN Nickel Plated
Extra Long
K-34SNX Nickel Plated 3" Long

Glass Handles

Replacements for glass "bridge" handles used on antique furniture. These handles can also be used for other applications. Includes two nickel plated screws. Projects 1-1/4". Center-to-center mounting is 3"



- K-50G** Clear
- K-52G** Milk White
- K-53G** Black
- K-55G** Cobalt Blue
- K-56G** Ruby Red
- K-57G** Depression Green
- K-58G** Milk Green (Jadite)
- K-59G** Milk Blue (Delphite)
- K-71G** Peacock Blue
- K-72G** Amethyst
- K-73G** Depression Pink
- K-74G** Amber

Fluted Glass Handle



K-70G Fluted Glass Handle
3" Center to Center Mounting

Octagonal Glass Knob with Brass Base



Elegant octagonal glass knob with brass base. Very high quality, Mounts from rear with machine screw. 1-1/4" Diameter. Projects 1-1/8".
KF-22C Clear
KF-25C Depression Green

Keyhole Covers

Stamped Brass Keyhole Covers



S-116
1" Diameter



S-118
1-1/2" x 1"



S-119
1" x 1-1/2"



E-5
2-1/2" x 1-3/8"



1" Diameter
E-2 Brass
E-2AB Antique Brass



E-2A
1-1/2" x 1"



E-2B
1" x 1-1/2"



E-17
1-1/2" Diameter



1-7/8" x 1-1/4"
E-21 Brass
E-21AB Antique Brass



1-7/8" x 1-1/8"
E-22 Brass
E-22AB Antique Brass



S-121
2-1/2" x 1-1/8"



E-33
1-1/4" Diameter

Keyhole Inserts

Cast Brass



E-1B
3/4" High



E-1D
5/8" High
5/16" Wide

Stamped Brass



BE-1E
1/2" x 7/8"



E-20
1/2" x 3/4"

Wood Keyhole Covers

Oak Keyholes



O-2
1" Diameter



O-3
1-1/4" Diameter



WK-24
1-1/4" x 1-1/4"

Walnut Keyholes



W-2
1" Diameter



W-3
1-1/4" Diameter



WK-20
1-1/4" x 1-1/4"

Cast Brass Keyhole Covers



E-11S
2" x 1-1/2"



C-212
2" x 1-1/4"



2-1/4" x 1-1/8"
E-37 Brass
E-37AB Antique Brass



C-224
5/8" x 2-1/2"

Flush Mounted Steel Locks

Two way keyhole allows lock to be mounted inside door or drawer. Bolt throws left or right so that lock can be used on left or right doors. Brass plated steel.

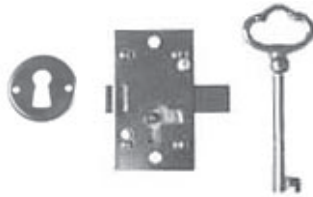

L-1B 1" Wide x 1-3/4" High. Includes brass plated key and brass keyhole cover.



L-3B 1-3/16" Wide x 2-5/8" High. Includes two brass plated keys.

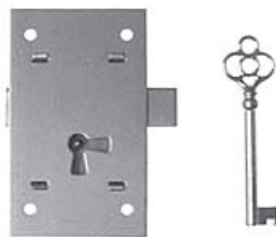

L-2 Flush Mounted Lock
Two way keyhole allows lock to be mounted inside door or drawer. Bolt throws left or right so that lock can be used on left or right doors. Plain steel. Lock is 1-3/4" Wide x 3" High. Includes brass plated key.

Heavy Flush Mounted Lock

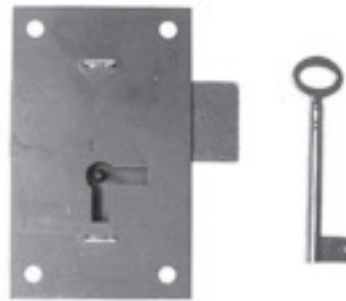

This heavy flush mounted steel lock can be used for left or right doors. It is perfect for armoires, wardrobes or other large cabinets. The lock can also be used for large drawers. Plain steel with nickel plated key.

L-4 2-1/8" Wide x 3-1/2" High

Lock for Clock Case or Curio Cabinet



Narrow lock for clock cases or curio cabinets. Can be used for left or right doors. Lock case is 13/16" Wide x 2" High. Overall height tip to tip is 2-7/8" Antique bronze finish with die cast key.

L-5 Lock

Full-Mortise Lock



S-15 Full-Mortise Lock
Lock can be used for drawers and right-hand doors. Steel. Includes die-cast key. 1-7/16" High x 1" Wide. Pin is centered 11/16" down from top of lock.

Roll Top Desk Locks



LRT-4 Roll Top Desk Lock
Square cornered roll top lock used to restore antique desks. Includes lock, receiver, keyhole cover and two keys.

Lock Plate: 3-1/4" x 5/8"

Lock Body: 1-3/4" x 1-3/8"

Receiver: 2-3/8" x 13/16"

Keyhole Cover: 3-3/4" x 1-3/8"



LRT-6 Roll Top Desk Lock
Round cornered lock for new desks. Includes lock, receiver and two keys.

Keyhole cover not included.

Lock Plate: 3-3/8" x 11/16"

Lock Body: 1-13/16" x 1-1/2"

Receiver: 2-3/4" x 1"



KY-8 Roll Top Desk Key
Brass plated die-cast roll top desk key.

Overall Size: 2-1/2" x 1"

Barrel Length: 1-3/8"



E-16 Keyhole cover
Keyhole cover for roll top desk lock. Brass. 3-3/4" x 1-3/8"

Locks

Brass and Steel Half-Mortise Locks

These high quality brass and steel locks can be used for drawers and doors. All exposed parts of the lock are polished brass. The body that houses the lock mechanism is steel. Each lock is supplied with two nickel plated malleable iron keys.



S-20L Half-Mortise Lock

This lock can be used for drawers or left door. **See chart on this page for lock size.**



S-20R Half-Mortise Lock

This lock can be used for drawers or right door. **See chart on this page for lock size.**

Brass and Steel Chest Lock

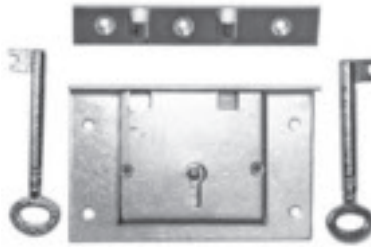

High quality brass and steel strong box or chest lock. Can be used as a replacement lock on old chests. All exposed parts are polished brass. The body that houses the lock mechanism is steel. Includes two nickel plated malleable iron keys.

S-7E Brass Chest Lock

Brass and Steel Box Locks

Can be used for lap desks, jewelry boxes, game boxes or any box with a hinged lid. All exposed parts of the lock are polished brass. The body that houses the lock mechanism is steel. Includes a nickel plated malleable iron key. **See chart on this page for lock sizes.**



S-8 Box Lock

S-8K Extra key for S-8 Lock



S-9 Box Lock

S-9K Extra key for S-9 Lock

Steel Chest Lock



Half-mortise steel lock for chests, boxes, and similar applications. Includes nickel plated die cast key. **See chart on this page for lock sizes.**

S-10 Steel Chest Lock

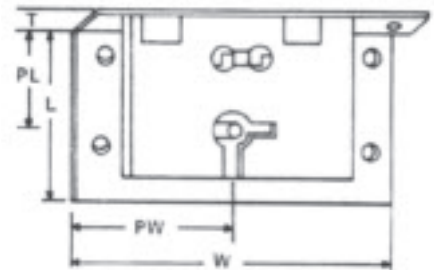

Use this chart for determining the size of locks S-7E through S-20R.

Stock No.	Size of Plate		Distance to Center of Pin		Thickn-ess
	W	L	R	PW	
S-7E	3-1/2"	2-1/4"	1-1/4"	1-3/4"	5/8"
S-8	1-1/2"	1"	3/4"	3/4"	3/8"
S-9	2"	1-1/4"	1"	1"	7/16"
S-10	2-5/8"	1-1/2"	1"	1-1/4"	5/8"
S-20L	3"	1-1/2"	5/8"	1-11/16"	3/8"
S-20R	3"	1-1/2"	5/8"	1-11/16"	3/8"

NOTE: Please check dimensions carefully before ordering locks. It is important that the key locator pin is centered at the top of the keyhole opening.

Steel Half-Mortise Locks



L-20R Half-Mortise Lock
Rounded half-mortise lock for drawers and right-hand doors. Steel. Includes key. Lock is 1-3/4" wide x 1-9/16" deep. See illustration on this page for dimensions.



L-40R Half-Mortise Lock
Rounded half-mortise lock for drawers and right-hand doors. Steel. Includes nickel-plated key. Lock is 1-3/4" wide x 1-7/8" deep. The distance from the center of the pin to the top of lock is 7/8".



L-20L Half-Mortise Lock
Rounded half-mortise lock for left-hand doors. Same as L-20R except for the position of the keyhole.



L-40L Half-Mortise Lock
Rounded half-mortise lock for left-hand doors. Same as L-40R except for the position of the keyhole.

Use the illustration below for locks L-20L and L-20R.

Note: Locks L-40R and L-40L are deeper than L-20L and L-20R. The overall height of the L-40 locks is 1-7/8" and the distance from the center of the pin to the top of the lock is 7/8".

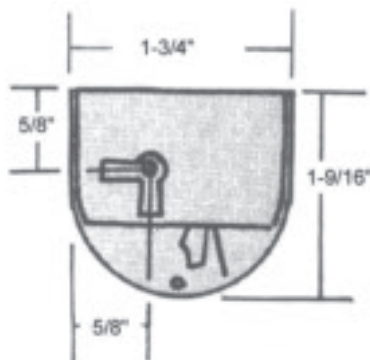

Thickness 3/8"

Flush Mounted Steel Locks

Two way keyhole allows lock to be mounted inside door or drawer. Bolt throws left or right so that lock can be used on left or right doors. Brass plated steel.

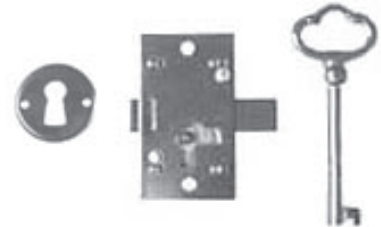

L-1B 1" Wide x 1-3/4" High.
Includes brass plated key and a brass keyhole cover.



L-3B 1-3/16" Wide x 2-5/8" High.
Includes two brass plated keys.

Full-Mortise Locks

Reproduction of full-mortise locks used in old American furniture.



S-15 Full-Mortise Lock
Lock can be used for drawers and right-hand doors. Steel. Includes die-cast key. 1-7/16" High x 1" Wide. Pin is centered 11/16" down from top of lock.

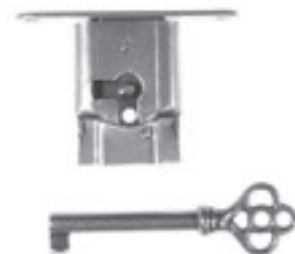

S-15S Full-Mortise Lock
with Mounting Plate
Same as S-15 lock shown above except that it includes a 2-1/8" x 3/8" mounting plate.

Keys



KY-11 Key
Nickel plated malleable iron.
Overall Size: 1-1/4" x 5/8"
Barrel Length: 5/8"



KY-3 Key
Brass plated die-cast key.
Overall Size: 2-1/2" x 3/4"
Barrel Length: 1-1/2"



Solid Brass Fancy Key
Overall Size: 3-1/4" X 1-3/8"
Barrel Length: 1-1/2"
KY-9 Brass
KY-9AB Antique Brass
KY-9HAC Antique Copper



KY-1 Solid Brass Key
Overall Size: 1-7/16" x 3/4"
Barrel Length: 1/2"



KY-3AB Key
Die-cast key with antique brass finish.
Overall Size: 2-1/2" x 3/4"
Barrel Length: 1-1/2"



KY-13 Key
Die-cast key with statutory bronze finish.
Overall Size: 2-1/8" x 5/8"
Barrel Length: 1-3/8"



KY-1L Solid Brass Key
Overall Size: 1-7/8" x 13/16"
Barrel Length: 1"



KY-4 Key
Brass plated die-cast key.
Overall Size: 2-3/8" x 7/8"
Barrel Length: 1-7/8"



Die-cast key. Fits our **L-40L** and **L-40R** Locks.
Overall Size: 2-1/4" x 3/4"
Barrel Length: 1-1/2"
KY-14 Nickel Plated
KY-14AC Antique Copper



Overall Size: 2-5/16" x 3/4"
Barrel Length: 1-3/4"
KY-6 Brass Plated
KY-6N Nickel Plated



Brass plated die-cast key. This popular key fits over 80% of the old American furniture locks.
Overall Size: 2-1/2" x 1"
Barrel Length: 1-1/2"
KY-2 Bright Brass
KY-2AB Antique Brass



Large die-cast key. Fits our **L-3B** Lock.
Overall Size: 2-7/8" x 1"
Barrel Length: 1-5/8"
KY-7 Nickel Plated
KY-7B Brass Plated



L-4K Key
Nickel plated malleable iron. Fits our **L-4** Lock.
Overall Size: 2-5/8" x 3/4"
Barrel Length: 1-3/4"

Roll Top Desk Keys



KYF-1 Solid Brass Fancy Key
Overall Size: 3" X 1-3/8"
Barrel Length: 1-1/2"



KYF-2 Solid Brass Fancy Key
Overall Size: 3-1/8" X 1-1/4"
Barrel Length: 1-1/2"



SKB Solid Brass Blank Key
Overall Size: 2-1/4" x 1"
Barrel Length: 1"



SGS Solid Brass Key
Fits many old American furniture locks.
Overall Size: 2-11/16" x 1"
Barrel Length: 1-1/2"



SKS Brass Key
Solid brass key fits 80% of the old American furniture locks.
Overall Size: 2-1/4" x 1"
Barrel Length: 1"



KY-8 Roll Top Desk Key
Brass plated die-cast roll top desk key. Fits many new roll top desk locks.
Overall Size: 2-1/2" x 1"
Barrel Length: 1-3/8"



M-4K Roll Top Desk Key
Key blank for roll top desk lock. Must be filed to operate lock.
Overall Size: 2-1/4" x 1"
Barrel Length: 1-1/4"

Skeleton Keys

Beautiful and well-made skeleton keys for house doors. Will open most bit-key locks on the market. This key was designed to work as a master key for antique mortise and rim architectural locks. High tensile forged brass. Featuring a double notched bit.

Overall Length: 3-1/8"
Bit: 3/8" Wide x 3/8" High



KY-30 Polished Brass
KY-30N Nickel Plated

Sample Key Rings

These sample key rings are great for antique shops, furniture restorers, locksmiths or anyone who needs to find the right key for a lock.



KY-10S Sample Key Ring
No more guessing which keys to order. Ten of our most popular keys on one ring. Includes one of each of the following keys:

KY-1	KY-3AB	KY-14
KY-2	KY-4	KY-9
KY-2AB	KY-6	
KY-3	KY-7	

NOTE: Key selection subject to change.



KY-20S Sample Key Ring
A total of 20 popular keys on one ring. Includes one of each of the following keys:

KY-1	KY-6N	KY-14AC
KY-1L	KY-7	KYF-1
KY-2	KY-8	L-4K
KY-2AB	KY-9	S-9K
KY-3AB	KY-11	SGS
KY-4	KY-13	SKS
KY-5	KY-14	

NOTE: Key selection subject to change.

Hinges

Solid Brass Butt Hinges



H-813 Brass Butt Hinge
Precision machined extruded brass cabinet hinges with ball tips. Heavy guage (3/32" leaf thickness). 2-1/2" High x 1-3/4" Wide. Overall Height: 3-1/8" Screws included.
Sold Each

Plated Steel Butt Hinges



Plated steel butt hinges with ball tips. Size fully open: 2" High x 1-3/8" Wide. Overall height: 2-1/2"
Sold in pairs with screws.
HB-821 Brass Plated
HB-821N Nickel Plated

Hinges With Finials



Plated steel butt hinge with finials. Size fully open: 1-5/8" Wide x 2-1/2" High. Overall height including finials: 3-1/2" Sold in pairs with screws.
HB-59 Brass Plated
HB-59AB Antique Brass Finish
HB-59N Nickel Plated

Steel Butt Hinges

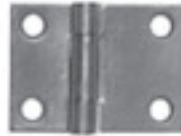

I-31 Steel Butt Hinges
Butt hinges for old cabinet doors. Sold in pairs with screws. Overall Size: 1-3/16" High x 1-5/8" Wide.
Narrow Leaf: 1/2" Wide
Wide Leaf: 3/4" Wide

Desk Hinges



HB-70 Slant Top Desk Hinges
Brass plated hinge and support for slant top desk lids. Sold in pairs with screws. Overall Size: 3/4" Wide x 7" Long. Leaf Thickness: 1/8"

Sewing Machine Hinges



HSM-6 Sewing Machine Hinges
Economical steel sewing machine hinges. Sold in pairs with screws. Statuary bronze finish. Size fully open: 1-1/4" High x 3-1/4" Wide



HSM-8 Sewing Machine Hinges
Solid brass sewing machine hinges. Sold in pairs with screws. Size fully open: 1-3/16" High x 2-13/16" Wide

Butler Tray Hinges



Heavy extruded solid brass Butler tray hinge with rounded ends. Leaf spring locks hinge at 90° and 180°. Sold in pairs with screws. Size fully opened: 1-1/2" High x 2-7/8" Wide
H-10 Polished Brass
H-10AB Antique Brass



Heavy extruded satin brass Butler tray hinge with square ends. Leaf spring locks hinge at 90° and 180°. Sold in pairs with screws. Size fully opened: 1-1/2" High x 2-1/2" Wide
H-10ASB Satin Brass

Drop Leaf Table Hinges



HS-3



HS-1

Steel hinges for drop leaf tables. Sold each with screws.
HS-3 2-7/8" Long x 1-1/4" Wide
Short Leaf: 1-1/4"
Long Leaf: 1-3/8"
HS-1 3-1/8" Long x 1-7/16" Wide
Short Leaf: 1-3/8"
Long Leaf: 1-3/4"

Pie Safe Hinges



HB-9 Pie Safe Hinges
Steel pie safe hinges. Hinge is 1-1/2" High x 1-1/2" Wide fully opened. Sold in Pairs. **Screws not included.**

Butterfly Hinge



Steel butterfly hinge. Flush mount. 2-1/4" Wide x 2" High Sold in pairs with screws.

HB-92 Brass Plated
HB-92AB Antique Brass
HB-92AC Antique Copper
HB-92N Nickel Plated
HB-92ORB Oil Rubbed Bronze

Concealed Hinges



H-303 Concealed Hinge
Brass plated steel Soss hinge. Plate: 1-1/2" Long x 1/2" Wide. Depth of Mortise: 5/8"



HC-91 Concealed Hinge
Solid brass cylinder hinge. 9/16" Diameter

Art Deco Hinges

Perfect for restoring Hoosier type cabinets made in the 1930s and 1940s. Can be used for many other applications. Available for flush or 3/8" offset doors. Solid Brass. Sold in pairs with screws.

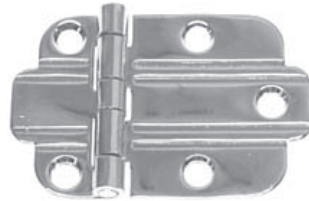

Flush mount Art Deco Hinge. Size fully open: 2-14" Wide x 1-1/2" High

I-35 Polished Brass
I-35BN Brushed Nickel
I-35N Nickel Plated
I-35ORB Oil Rubbed Bronze



3/8" Offset Art Deco Hinge. Size fully open: 2-14" Wide x 1-1/2" High

I-36 Polished Brass
I-36BN Brushed Nickel
I-36N Nickel Plated
I-36ORB Oil Rubbed Bronze

Hoosier Cabinet Hinge



Our most popular Hoosier style hinge. 2-1/4" Wide x 1-1/2" High. 3/8" Offset.

I-11 Polished Brass
I-11N Nickel Plated

Amoire Hinges

High quality solid brass extruded and milled, swaged "Flag" hinges with steeple tips for armoires, wardrobes, clock case and cabinet doors. Comes in two orientations: Left-Hand and Right-hand. The upper (door) leaf can be lifted off the lower (frame) leaf. Non-mortise hinge. Antique Brass Finish. **Sold Each**

Height (Not including tips): 3-1/4"
Leaf Height: 1-9/16"
Total Width (Open): 1-3/4"
Leaf Width: 3/4"
Leaf Thickness: 3/32"
Knuckle Diameter: 3/8"
Height of Tip: 1"



HB-41AB

HB-42AB

HB-41AB Left Hand Hinge
HB-42AB Right Hand Hinge

Cast Iron Hinges



I-60CI Cast Iron Hinges
Cast iron flush mounted hinge has many applications. 1-1/4" High x 2" Wide fully open. Screws included. Sold Each. **Lacquered**

File Cabinet Hardware



FC-11 File Card Frame
Brass Plated
3-3/16" Wide x 1-1/2" High



FC-12 File Card Frame
Brass Plated with Pull
3-3/16" Wide x 1-1/2" High



F-9 File Cabinet Handle
Polished cast brass handle for file cabinets and other applications. Overall Size: 4-3/4" Long x 1-3/16" High. Screws on 4" centers.



FC-13 File Card Frame
Brass Plated
2-1/8" Wide x 1-1/8" High



File Card Frame
Available in four finishes.
Screws Included.
3-7/16" Wide x 1-5/16" High
FC-20 Brass Plated
FC-20AB Antique Brass
FC-20B Black
FC-20N Nickel Plated



F-33 File Card Frame
Polished Cast Brass
Screws Included
2-15/16" Wide x 2" High
Thickness: 1/8"



F-66 File Drawer Pull
Polished Cast Brass
Screws Included
Overall Size: 2-1/4" x 1-1/4"

Bookcase Hardware

Replacement hardware for stacking bookcases with retractable glass doors made by Globe-Warnicke and others.



BK-40 Bookcase Equalizer
Attaches to the top of the glass door and the back of the bookcase to keep the door centered when it is opened and closed. Steel.
Size: 24" Long x 7/16" Wide



Bookcase Side Straps
Interlocking straps mounted on the outside of each section to align stacks when they are placed side by side. Includes two wedges to secure straps. Steel. Sold by the pair.
BK-41 11-1/2" Long x 1" High
BK-42 17-1/2" Long x 1" High



BK-43 Bookcase Door Liner
Mounts inside cabinet to allow for smooth door operation. L-shaped rail can be cut to length. Steel. Sold by the pair.
Size: 10-1/2" Long x 1" High



BK-44 Book Case Door Stops and Pivot Brackets
Stops mount on frame and pivot brackets mount on door. When the closed door is pulled out, bracket pivots on stop until door is horizontal and can be pushed inside. Includes two stops and two brackets. Steel.



Bookcase Knob
5/8" Diameter
Projects 9/16"
Solid Brass
BK-9 Polished Brass
BK-9N Nickel Plated

Brass Bed Balls



A-40 Bed Post Ball
Small brass bed ball for iron or brass beds. Ball Diameter: 1-3/4" Height: 2-1/4" Thread: 3/8"



A-39 Bed Post Ball
Polished brass bed ball for iron or brass beds. Ball Diameter: 2" Height: 2-1/2" Thread: 3/8"



A-33 Bed Ball Washer
Fits on top of bed post directly below bed ball. Diameter: 1-3/4" Height: 1/2"



K-21 Bed Bolt Cover
Cast brass bed bolt cover for bedpost bolts. Diameter: 1-5/8" Height: 2-1/8"



BB-40 Bed Bolt
Black steel bed bolt with square nut. Bolt Head: 7/16" Square Overall Length: 6-1/8" Thread: 3/8" x 16



BF-18 Bedfast Set
Heavy wrought steel. Easy to install. Plate is 5" High x 5/8" Wide. Sold in sets of 4 Plates and 4 Hooks.



BF-20 Bedfast Set
Steel plate is 2-1/2" Wide x 3-5/8" High. Sets consists of 4 Plates, 8 Short Pins and 8 Long Pins.



BF-23

BF-24



BF-25

Cast Iron Bedfast Sets

Cast iron bedfast sets for repairing old beds or building new beds. Set consists of 4 Plates and 4 Hooks.

BF-23 Plate Size: 4" High x 1" Wide

BF-24 Plate Size: 4-13/16" High x 1-1/8" Wide

BF-25 Plate Size: 4-9/16" High x 1-3/16" Wide

Horseshoe Rail Hook: 2-5/8" High x 2-11/16" Wide

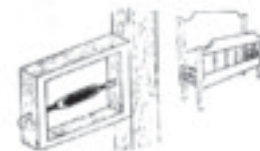
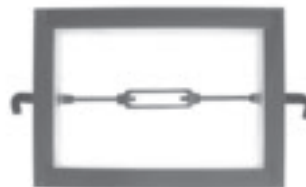

BR-10 Short Bed Rails

For displaying head board and foot board. 6" X 9" wood frame with hooks and turnbuckle. SOLD IN PAIRS.

Coat Hooks



A-1 Double Coat Hook
 Cast Brass. Collar and bolt provided for rear mounting. Size: 3-7/8" High x 5-1/4" Wide
 Projects 2-3/8" Base Diameter: 1-1/4"



A-4 Coat Hook
 Cast Brass, 4-1/2" High, Projects 3"
 Base: 2" High x 1-1/8" Wide



A-8 Coat Hook
 Cast Brass, 5-1/2" High
 Projects 3-1/4"
 Base: 2-3/8" High x 9/16" Wide



A-15 Coat Hook
 5" High, Projects 3-5/8"
 Base: 1-3/8" High x 1-1/4" Wide



A-14 Coat Hook
 Cast Brass, 1-1/2" High
 Projects 2"
 Base: 1-1/2" High x 1-3/16" Wide



A-23 Coat Hook
 Cast metal alloy coat hook with
 1" diameter Porcelain knobs.
 Antique brass finish. 5-1/2"
 High
 Projects 4" Base: 1-3/4" High x
 2" Wide

Cast Iron Coat Hooks



A-4CI Cast Iron Coat Hook
Black cast Iron, 4-1/2" High
Projects 2-3/4"
Base: 2" High x 1-1/8" Wide



A-15CI Cast Iron Coat Hook
Black cast iron, 5" High
Projects 3-5/8"
Base: 1-3/8" High x 1-1/4" Wide



A-9CI Cast Iron Coat Hook
Black cast iron with acorn ends.
Hook is 3" High. Projects 3-1/8"
Base: 2" High x 1-3/4" Wide

Cast Iron Coat Hooks



A-12CI Victorian Eastlake Hook
Quality plain cast iron coat hook.
2-3/4" High. Projects 3-3/16"
Base: 2-5/16" High x 1-7/16" Wide



A-19CI Hall Tree Hook
Cast iron with dark rust brown
painted finish. 6-7/16" High
Projects 3-11/16"
Base: 2-3/4" High x 1-1/4" Wide



A-25 Die Cast Coat Hook
Zinc alloy die cast coat hook with antique
brass finish. Dates back to 1930s.
Height: 5"
Projects: 3-1/2"

Table Hardware



I-18 Table Leaf Lock
Solid Brass
Diameter: 2"



TL-8 Table Lock
Cam type table lock. Brass plated steel.
Latch Base: 2-5/8" x 1-3/8"
Catch Base: 2-1/4" x 5/8"



C
3-1/2" x 1-15/16"



B
10" Long



A
2-3/8" x 1-7/16"

TB-5 Cast Iron Table Leaf Support

Reproduction of an old cast iron drop leaf table support. Part **A** fits on the end of bar **B** and attaches to the drop leaf. Part **C** attaches to the table apron and catches the forked end of the bar when the table leaf is up.



Drop-Leaf Table Supports

Heavy gauge steel supports for drop-leaf tables. See Table below for correct mounting dimensions.

- TB-14** 8" Long
- TB-15** 10" Long

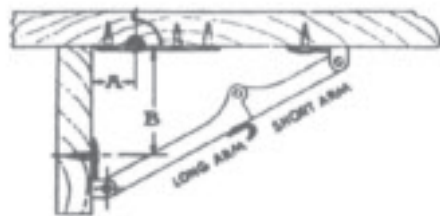

Dimension A	Dimension B TB-14	Dimension B TB-15
1/2"	2-13/16"	4-1/4"
1"	2-1/2"	4"
1--1/2"	2-1/8"	3-9/16"
2"	1-11/16"	3-1/4"
2-1/2"	1-3/16"	2-13/16"
3"	NA	2-3/8"



TBS-20 Hardwood Table Slides

Hardwood table slides are designed to provide constant leveling when table is fully extended and leaves are in place. For use with four legged tables. Slides are 30" long closed and 68" long fully extended. SOLD IN SETS OF TWO.

Table Hardware

Drop Leaf Table Hinges



HS-3



HS-1

Steel hinges for drop leaf tables.
Sold each with screws.

HS-3 2-7/8" Long x 1-1/4" Wide

Short Leaf: 1-1/4"

Long Leaf: 1-3/8"

HS-1 3-1/8" Long x 1-7/16" Wide

Short Leaf: 1-3/8"

Long Leaf: 1-3/4"



Table Top Leveler

Keeps table top and leaves even. Plain steel. Size: 3/4" Wide x 1-5/8" Long

TL-2 Each

TL-2D Package of Dozen



Table Top Fastener

1-1/4" Long x 3/4" Wide

3/8" Offset Plain steel.

TF-4 Each

TF-4/12 Package of Dozen



TP-10 Table Pin

1-1/4" Long x 3/8" Diameter

Sold by the dozen.

Hardwood

Stamped Brass Claw Feet

Stamped brass claw feet in three sizes. Available in polished brass or antique brass. **See table below for sizes.**



CS-7 Polished Brass

CS-7AB Antique Brass



CS-8 Polished Brass

CS-8AB Antique Brass



CS-9 Polished Brass

CS-9AB Antique Brass

	Rear Opening		Length
	Width	Height	
CS-7	1"	7/8"	1-1/4"
CS-8	1-5/16"	1-1/8"	1-7/8"
CS-9	1-5/8"	1-1/2"	2-5/8"

Stamped Brass Duncan Phyfe Toe Cap



C-8Z Duncan Phyfe Toe Cap

Rear Opening: 1-1/2" Wide x 1-1/2" High

Length: 2"

Pie Safe Tins and Hardware

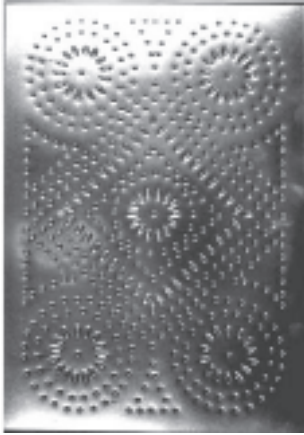

PST-8 Pie Safe Tin
Large Diamond Pattern
10" x 14"



PST-10 Pie Safe Tin
Vertical Wheat Pattern
10" x 14"



PST-11 Pie Safe Tin
Horizontal Wheat Pattern
14" Wide x 10" High

PST-7 Blank Pie Safe Tin
Blank pie safe tins for those who want to punch their own patterns. Size: 10" x 14"

Pie Safe Hinges

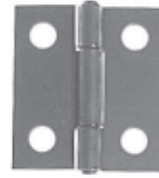

HB-9 Pie Safe Hinges
Steel pie safe hinges. Hinge is 1-1/2" High x 1-1/2" Wide fully opened. Sold in Pairs. **Screws not included.**



PK-12 Porcelain Knob
1" Diameter
Projects: 7/8"



BP-90 Turnbutton
Zinc Plated Steel
2" Long x 3/4" Wide



BP-90CI Turnbutton
Cast Iron
1-7/8" Long x 9/16" Wide

Pie Safe Plans



In the early 1900s large handsome cupboards like this could be found stocked with warm pies and fresh baked bread. This pie safe will fit in any room where extra storage space is needed. Our pie safe has three shelves and two drawers at the top.

The well detailed instructions include directions for punching the pie safe tins or we can provide pre-punched tins.

Size: 36" High x 32" Wide x 21" Deep

PSP-1 Pie Safe Plans

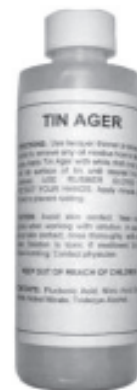

Tin Ager

Used to darken pie safe tins and other new tin items.

M-3T 8 Oz. Bottle

M-3TQ 32 Oz. Bottle

Miscellaneous Hardware

Spool Cabinet Decals



SCD-50 Clark's Decal
CLARK'S Spool cabinet paper decal. Blue & Gold on Cream background. Diameter: 5-15/16"



SCD-60 J&P Coats Decal
J&P COATS Spool cabinet vinyl decal. Black & Gold on Cream background. 7" Wide x 6-3/4" High



SCD-7 Spool Cabinet Decals
Spool cabinet paper decals have black letters on antique gold background. Each die-cut decal is 1-11/16" High x 9-7/16" Long. Sold in sets of 8.

Shop Keeper's Bells



LB-45 Shop Keeper's Bell
Cast brass bell and mounting bracket. Bell diameter is 2-7/8" and the bell height is 2-3/4". The steel band that attaches the bell to the mounting bracket is 8-1/4" long.



LB-56 Shop Keeper's Bell
Cast brass bell and mounting bracket. Bell diameter is 3". Mounting bracket is 2-5/8" Wide x 2-7/8" High. The steel band that attaches the bell to the mounting bracket is 10" long.

Desk Bells



Desk Bells
Old fashioned cast brass desk bells. 3" High x 3-1/2" Diameter
LW-50 Polished Brass
LW-50N Nickel Plated



LW-75 Desk Bell
Old fashioned antique Victorian desk bell. Solid Brass. 3-1/4" High. Base is 5-3/8" from foot to foot. Bell Diameter: 3"

Miscellaneous Hardware

Turn Buttons



BP-90 Turnbutton
Zinc Plated Steel with
Screw. 2" Long x 3/4" Wide



BP-90CI Turnbutton
Cast Iron with Screw
1-7/8" Long x 9/16" Wide



I-16 Brass Turnbutton
Cast brass turnbutton with
backplates for cabinet doors.
Polished solid brass. Screws
included. Diameter: 1-1/2"

Large Brass Handle



P-142 Cast Brass Handle
Polished cast brass handle can be
used for doors, drawers, chests or
windows.
Overall Length: 5-3/4"
Center to Center Mounting: 4-3/4"

Eyebolts and Backplates



M-1

M-1B

Bail Mounting Eyebolts

Sold in pairs with nuts
M-1 Brass Plated Eyes
M-1B Cast Brass Posts

Bail Mounting Washers



M-2 Stamped Brass, 5/16" Diameter
Sold in pairs.

Stamped Brass Backplates



K-6AWP

K-6BWP

K-6AWP 1" Diameter

K-6BWP 1-3/16" Diameter

Caster Sockets



C-4I Caster Sockets

Zinc plated steel caster socket for
casters with a grip neck stem such
as our **C-4 Series**. 3/4" Diameter
tack plate. Requires 3/8" x 1-5/8"
hole. **Sold Each**

Decorative Nails

Sold in packages of 50 or boxes of
1000.



S-1042 Seat Nail
Plain French Finish
3/4" Long



TKN-5 Decorative Nail
7/16" Woven Head
5/8" Long



TKN-6 Decorative Nail
1/2" Daisy Head
1/2" Long



TKN-7 Decorative Nail
1/2" Hammered Head
3/4" Long

Small Brass Plated Nails



S-N1S Brass Plated Nails
16 Gauge x 1/2" Long brass plated
escutcheon nails. Sold in pack-
ages of 100.

Miscellaneous Hardware

Hip Rest Clips



OC-27 HIP Rest Clips

Used to mount oak hip rests to chair.
Antiqued steel. 1" Long x 11/16" Wide x 1/2" High. Screw hole diameter: 1/4".
Sold in sets of 4 clips. Screws included.

Cut Nails

Sold in 4 Oz. Packages



CN-71 3/4" Clout Nail
Approx. 136 Nails per Package



CN-72 1" Headless Brad
Approx. 100 Nails per Package
(1.3 Oz. Package)



CN-73 1-1/4" Fine Finish Nail
Approx. 92 Nails per Package



CN-74 1-3/8" Shingle Nail
Approx. 58 Nails per Package



CN-75 1-3/4" Shingle Nail
Approx. 43 Nails per Package

Wood Screws

A variety of slotted-head wood screws especially selected for furniture repair. Many are hard to find types such as oval head, nickel plated, and old-fashioned plain steel (not plated) screws. These plain steel screws are perfect for restoring antique furniture and other applications where bright plated screws are not desirable. **Sold in packages of 25 or 100.**



Flat Head Wood Screws

Brass

SC-B212F	#2 x 1/2"
SC-B312F	#3 x 1/2"
SC-B412F	#4 x 1/2"
SC-B512F	#5 x 1/2"
SC-B558F	#5 x 5/8"
SC-B658F	#6 x 5/8"
SC-B81F	#8 x 1"

Plain Steel

SC-S634F	#6 x 3/4"
SC-S858F	#8 x 5/8"
SC-S81F	#8 x 1"
SC-S8114F	#8 x 1-1/4"
SC-S8112F	#8 x 1-1/2"
SC-S1058F	#10 x 5/8"
SC-S10114F	#10 x 1-1/4"
SC-S10112F	#10 x 1-1/2"
SC-S102F	#10 x 2"
SC-S10212F	#10 x 2-1/2"



Oval Head Wood Screws

Brass

SC-B412O	#4 x 1/2"
SC-B558O	#5 x 5/8"
SC-B658O	#6 x 5/8"
SC-B8114O	#8 x 1-1/4"

Nickel Plated

SC-N412O	#4 x 1/2"
SC-N558O	#5 x 5/8"
SC-N658O	#6 x 5/8"
SC-N8114O	#8 x 1-1/4"

Plain Steel

SC-S8114O	#8 x 1-1/4"
-----------	-------------



Round Head Wood Screws

Brass

SC-B212R	#2 x 1/2"
SC-B312R	#3 x 1/2"
SC-B338R	#3 x 3/8"
SC-B358R	#3 x 5/8"
SC-B658R	#6 x 5/8"

Nickel Plated

SC-N658R	#6 x 5/8"
----------	-----------

Plain Steel

SC-S658R	#6 x 5/8"
SC-S834R	#8 x 3/4"
SC-S101R	#10 x 1"

NOTE:

Use **SC-S834R** #8 x 3/4" Round Head or **SC-S101R** #10 x 1" Round Head for Hoosier side brackets.

NOTE: Kennedy Hardware is one of the few remaining sources for plain steel slotted wood screws.

Miscellaneous Hardware

Mirror Supports



MS-5 Mirror Supports
American style mounting hinges for mirrors. Brass plated steel. One pair mounts one mirror. Sold in pairs. Each Clamp: 1-1/4" x 3/4" Pin: 2" Long x 1/4" Dia. Overall size: 2" x 1-1/4"



MS-7



MS-7AB

Friction Mirror Supports

Steel friction hinges for mirrors. One set mounts one mirror. Sold in pairs. Each Clamp: 1-1/2" x 1/2" Pin: 2" Long x 1/4" Dia. Overall size: 2" x 1-1/2"
MS-7 Brass Plated
MS-7AB Antique Bronze Finish

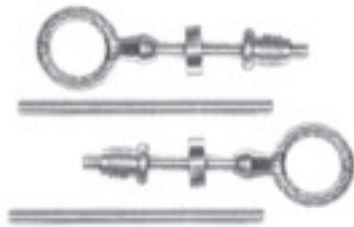

M-5B Cheval Mirror Support
Complete set for mounting swing mirror. Includes cast brass rings, brass friction washers, threaded brass inserts and two lengths of screws (2-1/4" and 3-1/2"). Ring diameter: 1-1/4"



M-108 Desk Lid Support
Heavy duty replacement lid supports for drop front desks, blanket chests and similar applications. Brass plated steel. Sold in pairs (Right and Left). Overall Length: 10-3/8" Arm Width: 9/16"

Shelf Rests



Brass Plated Steel
Requires 1/4" Diameter Hole
BP-83 Package of Dozen
BP-83C Package of 100



Spoon type. Brass plated steel.
Requires 1/4" Diameter Hole
BP-85 Package of Dozen
BP-85C Package of 100

Drawer Stops

Sold by the Dozen



DS-1 Drawer Stops
Double-pointed drawer stops. 3/4" Wide x 11/16" High



DS-2 Drawer Stops
Reproduction of drawer stops used on most American oak furniture. 3/4" Wide x 11/16" High

Nylon Furniture Glides



GL-10 5/8" Diameter, 5/8" Nail
GL-20 3/4" Diameter, 3/4" Nail
GL-30 7/8" Diameter, 3/4" Nail

Sold by the Dozen, 100, or 1000

Dozen	100	1000
GL-10	GL-10C	GL-10M
GL-20	GL-20C	GL-20M
GL-30	GL-30C	GL-30M

Bullet Catches

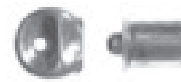

Brass Plated Bullet Catches
BP-95 1/4" Diameter
BP-96 3/8" Diameter

Friction Catches



BP-94 Spring Catch
Spring loaded friction catch for doors without an external latch. Zinc plated steel.



BP-48 Friction Catch
Spring steel friction catch for doors without an external latch. Brass plated. Catch: 1" x 3/4" Clip: 1-1/4" x 5/16"

Brass Flat Hooks



H-22 1" Long
H-24 1-1/2" Long

Cast Iron Hinges



H-50CI Cast Iron Hinges
 Reproduction of a vintage cast iron cabinet hinge. Hinge size is 2" x 2". Overall height with finials is 4"
Sold in pairs with screws.



H-51CI Cast Iron Hinges
 Reproduction of a vintage cast iron cabinet hinge. Hinge size is 2-1/2" x 2-1/2". Overall height with finials is 4-1/2"
Sold in pairs with screws.



E-835 Keyhole Cover
 This heavy polished brass stamped keyhole can be used for many applications. The overall size is 1-3/4" High x 1-3/16" Wide. Keyhole is 13/16" High. Includes mounting screws.

Door Hinges

These economical brass plated steel hinges are exact replicas of old style hinges. They have features found in more expensive hinges including classic ball tips, square corners, and removable stainless steel pins. The 1/8" thick swaged leaves provide for extra durability. 9/16" diameter ball tips. **Sold each with screws.**



3-1/2" x 3-1/2" Hinges
 Total height including ball tips: 4-3/4"
H-81BP Lacquered Polished Brass
H-81ORB Oil Rubbed Bronze



4" x 4" Hinges
 Total height including ball tips: 5-1/2"
H-82BP Lacquered Polished Brass
H-82ORB Oil Rubbed Bronze

Window Hardware



L-40B Sash Latch
 Polished cast brass sash latch for windows. Screws included.
 Latch Base: 2-1/2" x 7/8"
 Catch Base: 2-1/2" x 9/16"



F-9 Sash Lift
 Polished cast brass handle is ideal sash lift. Can also be used as file cabinet handle. Overall size is 4-3/4" Long x 1-3/16" High. Screws on 4" centers.



MS-81 Cast Iron Mail Slot
 Authentic looking Victorian cast iron mail slot. High quality cast iron with very good detail. 9-3/4" Wide x 3-1/8" High. Includes front and back plates and mounting screws.

Architectural Hardware

Octagonal Glass Door Knob Sets

Octagonal Glass Door Knob Sets with Polished Brass or Oil Rubbed Bronze bases. This set can be used in both modern doors with our **LH-500 Series** latches and in the old doors. The glass knobs are 2-1/4" in diameter and the base shank is .61". Includes two knobs, spindle, set screws and Allen wrench.



AH-51 Polished Brass



AH-51ORB Oil Rubbed Bronze

Standard Tubular Passage & Privacy Latches

High quality tubular door latch for both left and right hand doors. 2-3/8" backset. Available in passage or privacy configurations. Included in the package is one tubular latch, one solid brass face plate, one solid brass striker plate, one alignment piece and mounting hardware.



Polished Brass

Striker plate: 2-1/4" x 1-3/4".
Face plate: 2-1/4" x 1".
LH-500 Passage Latch
LH-501 Privacy Latch



Oil Rubbed Bronze

Striker plate: 2-1/4" x 1-3/4".
Face plate: 2-1/4" x 1".
Striker plate and face plate are finished in oil rubbed bronze.
LH-500ORB Passage Latch
LH-501ORB Privacy Latch

Round Backplate Sets

Round Backplate Set in Polished Brass or Oil Rubbed Bronze. Works with our **AH-51 Series** glass knob sets on modern doors with our **LH-500 Series** latches. Backplate diameter is 2-3/4" and the collar opening is 5/8"

Package contains two backplates and two mounting screws. Available for passage or privacy latches.



Polished Brass

AH-73 Passage
AH-73L Privacy



Oil Rubbed Bronze

AH-73ORB Passage
AH-73LORB Privacy

Skeleton Keys

This key was designed to work for most antique mortise and rim architectural locks. High tensile forged brass.

Overall Length: 3-1/8"
Bit: 3/8" Wide x 3/8" High



KY-30 Polished Brass
KY-30N Nickel Plated

Novelty Locks and Keys

Reproduction Antique Padlocks

These large replica padlocks are both decorative and functional. Each padlock weighs more than a pound. Although these locks are new they look like old locks that have been restored. They are not only interesting but they actually work.



APL-2 Replica Atlas Padlock

This large padlock is furnished with two keys. The following is stamped on the front of the lock: "8 LEVERS", "21", "ATLAS" and "No100".

Height: 4-1/8"
Width: 2-1/4"
Depth: 1"



APL-4 Replica US Mint Padlock

This large padlock is furnished with two keys. The following is stamped on the front of the lock: "8 LEVERS", "21", "US MINT" and "No100".

Height: 4-1/8"
Width: 2-1/4"
Depth: 1"

Jailer Key Rings

These interesting key rings are strictly ornamental.



JKR-4 Jailer Key Ring

Six cast iron keys on a 3" diameter steel ring. This key ring weighs more than a pound. The keys are 6-3/4", 5-7/8", 4-1/2", 4-1/8", 3-7/8" and 3-3/8" long. The overall height of the key ring when hanging from a hook is 9-1/4". Antique brown finish.



JKR-8 Jailer Key Ring

Three cast iron keys on a 3-3/8" diameter steel ring. The three keys are 4-5/8", 4-1/2" and 4-1/2" long. The overall height of the key ring when hanging from a hook is 8". Antique black finish with brown highlights.



JKR-6 Jailer Key Ring

Three cast iron keys on a 4" diameter steel ring. The three keys are 5-1/4", 4-11/16" and 3-3/16" long. The overall height of the key ring when hanging from a hook is 8-1/2". Antique black finish with brown highlights.



JKR-9 Brass Jailer Key Ring

Five cast brass keys on a 4" diameter brass plated ring. The keys are 6-1/8", 5-3/8", 4-13/16", 4-1/4" and 2-15/16" long. The overall height of the key ring when hanging from a hook is 10-1/8".

Wood Parts

Carved Walnut Pulls

Victorian style pulls carved from solid walnut. Available in three sizes. **Sold only in Pairs (one left and one right).**



WP-54 Small 4-1/8" x 1-5/8"



WP-55 Medium 5-5/8" x 2"



WP-57 Large 7-1/8" x 2-5/8"



B-W2



B-W1

Carved Oak Desk Handles

Ideal for roll top desks.

B-W2 5" x 1-1/4"

B-W1 7" x 1-3/8"



B-W5



B-W4

Plain Oak Desk Handles

B-W5 5" x 1-1/4"

B-W4 7" x 1-3/8"

Oak Hip Rests



O-20 Oak Hip Rests

Replacement hip rests for oak chairs. One end is flat to fit chair seat and the other end is carved out to fit the chair back. Approximately 6-1/2" high. Sold in pairs.



O-17 Oak Pyramidal Handle

Solid oak mission style pyramidal handle. 4-1/2" x 1-1/2" Matches O-15 and O-16 knobs.



W-7 Walnut Corner Ornament

Walnut corner ornament for picture frames. Size: 3" x 3" x 1-1/4"



SP-2 Shaker Pegs

Hardwood Shaker Pegs
Turned Length: 2-7/8"
Overall Length: 3-1/2"
Head Diameter: 7/8"
Tenon Diameter: 1/2"

Wood Keyhole Covers

Oak Keyholes



O-2
1" Diameter

O-3
1-1/4" Diameter



WK-24

1-1/4" x 1-1/4"

Walnut Keyholes



W-2
1" Diameter

W-3
1-1/4" Diameter



WK-20

1-1/4" x 1-1/4"

Oak Screw Hole Plugs



Sold in packages of 50

Button Head

OS-33 3/8"

OS-34 1/2"

OS-35 5/8"

Oak Appliques

These **American Made** Embossed Oak Carvings are produced from hand-tooled dies which date back to the turn of the century. The woods are selected for the best possible detail and finish look. The quality and finite detail of these appliques are un-equalled in the industry today.



AW-721
1-1/4" Diameter



AW-3448
1" x 1-3/4"



AW-3224
5/8" x 3-7/8"



AW-3205
1-5/8" x 2-7/8"



AW-3359
2-1/4" Diameter



AW-3346
2" x 3"



AW-3597
3" Diameter



AW-3312
2-1/2" x 4-3/4"



AW-3325
2-3/4" x 3-5/8"



AW-511
7" x 7"



AW-3218
1-3/4" x 9-1/4"



AW-3304
1" x 5-1/2"

Oak Appliques



AW-3332 Pair
2-1/2" x 5-1/2" Each



AW-3177
3" x 11"



AW-673 Pair
3" x 7-1/2" Each



AW-605
2-7/8" x 12-3/4"



AW-608 Pair
2-1/2" x 6" Each



AW-599
4-7/8" x 14-1/2"



AW-700
3" x 11"



AW-613
2-1/2" x 10-5/8"



AW-891
5-1/2" x 16"



AW-675
3-1/2" x 12"



AW-3584
3-3/8" x 17-7/8"

Oak Appliques



AW-567
5" x 5"



AW-3141 Pair
1-3/8" x 3-7/16" Each



AW-3248 Pair
1-5/8" x 3-3/8" Each



AW-538 Pair
9" x 2" Each



AW-3626
3-1/8" x 7-5/8"



AW-590
5" x 7"



AW-663 Pair
6" x 6" Each



AW-561 Pair
12" x 1-1/2" Each



AW-687 Pair
4-1/8" x 3-5/8" Each



Chair Parts



O-24 Oak Chair Spindle
 Turned Oak chair spindles. Overall Length: 11-1/4"
 Maximum Diameter: 7/8", Tenon Diameter: 3/8"

Morris Chair Parts

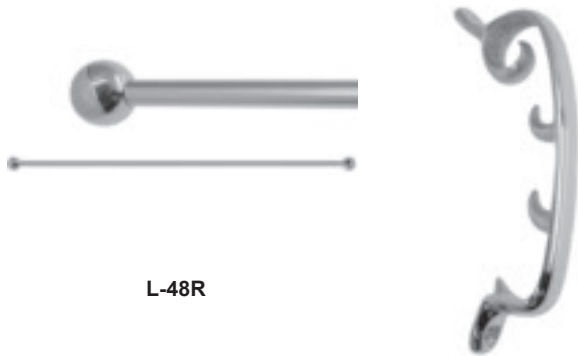

L-48R

L-49E

Morris Chair Brackets

Brass plated cast iron replacement brackets for the backs of Morris chairs. These brackets are made to accommodate most Morris chair configuration curves. Each bracket is 6-5/8" Long x 3/4" Wide. Sold in pairs.

- L-49E** Polished Brass
- L-49EAB** Antique Brass

Morris Chair Rods

Brass plated steel Morris chair rod with 1" diameter ball terminal finials. 3/8" diameter rod is 26-1/4" Long. Terminals are held in place with set screws which allow them to be removed so that rod can be trimmed to desired length.

- L-48R** Polished Brass
- L-48RAB** Antique Brass



OC-27 HIP Rest Clips

Used to mount oak hip rests to chair. Antiqued steel. 1" Long x 11/16" Wide x 1/2" High. Screw hole diameter: 1/4". Sold in sets of 4 clips. Screws included.

Decorative nails for fiberboard seats.

Sold in packages of 50 or boxes of 1000.



S-1042 Seat Nail
 Plain French Finish
 3/4" Long



TKN-5 Decorative Nail
 7/16" Woven Head
 5/8" Long



TKN-6 Decorative Nail
 1/2" Daisy Head
 1/2" Long



TKN-7 Decorative Nail
 1/2" Hammered Head
 3/4" Long

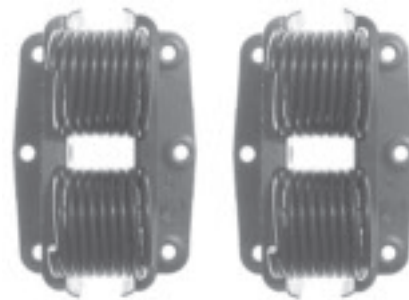

RS-42 Platform Rocker Springs

Replacement springs for platform rocking chairs. Base is 5" x 3-1/2". Overall height of spring is 2-1/4". Sold in pairs.



O-20 Oak Hip Rests

Replacement hip rests for oak chairs. One end is flat to fit chair seat and the other end is curved to fit the chair back. Approximately 6-1/2" high. Sold in pairs.

Pressed Fiberboard Seats

These fiberboard seats are pressed from original turn-of-the-century dies. The light reddish tan material has a leather-like appearance that can be stained, varnished, or painted. Seats can be trimmed easily with shears, a band saw, or a knife to the desired size. Install fiberboard seats using seat nails spaced 1" to 1-1/2" apart.



S-3012 Nesting Birds
Untrimmed Size: 14-1/2" x 14-1/2"
Minimum Trimmed Size:
12" Diameter



S-3022 Bows
Untrimmed Size: 14-1/2" x 14-1/2"
Minimum Trimmed Size:
Front: 12-3/4"
Back: 11-1/4"
Depth: 11-3/4"



S-3024 Small Daisy Seat
Untrimmed Size: 12-1/2" x 12-1/2"
Minimum Trimmed Size:
Front 10", Rear 9", Depth: 10"

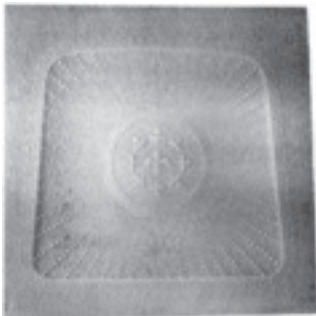

S-3080 Fleur-De-lis
Untrimmed Size: 14-1/2" x 14-1/2"
Minimum Trimmed Size:
Front: 14-1/4"
Back: 12-3/4"
Depth: 13-1/4"

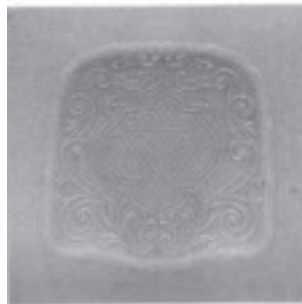

S-3040 Shield
Untrimmed Size: 14-1/2" x 14-1/2"
Minimum Trimmed Size:
Front: 12-1/2"
Back: 11"
Depth: 12-1/4"

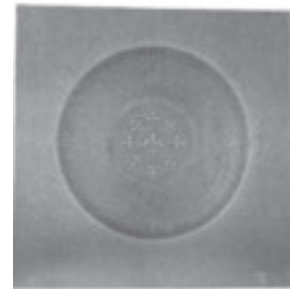

S-3070 Fleur-De-Lis
Untrimmed Size: 14-1/2" x 14-1/2"
Minimum Trimmed Size:
12" Diameter

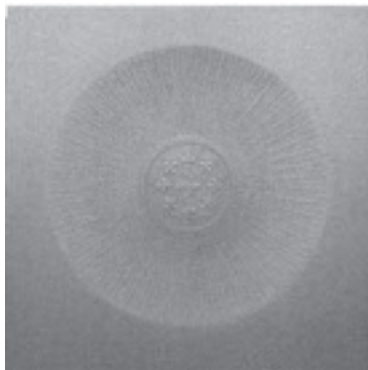

S-3018 Extra Large Fleur-De-Lis
Untrimmed Size: 18" x 18"
Minimum Trimmed Size:
15-1/2" Diameter

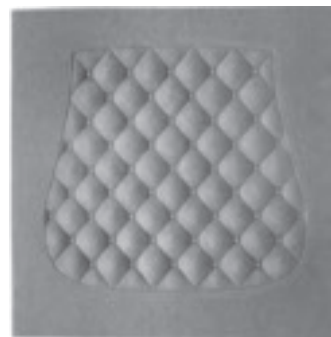

S-3300 Quilted Pattern
Untrimmed Size: 15-3/4" x 15-3/4"
Minimum Trimmed Size:
Front: 13-1/4"
Back: 10-1/2"
Depth: 12-3/8"

Pre-Woven Caning

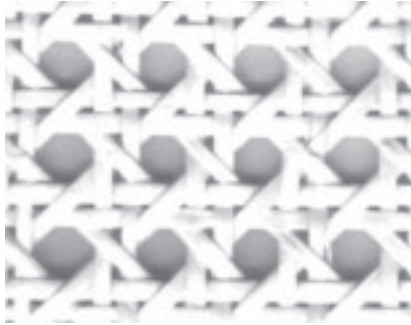

1/2" Fine Open Mesh

Pre-woven cane sets into the groove around the chair seat and is held in place with wood spline and glue. This 1/2" Fine Open Mesh caning is the correct size for most antique chairs. Sold by the foot.

S-312 12" Wide

S-318 18" Wide

S-314 14" Wide

S-324 24" Wide

S-316 16" Wide

Wood Spline

Used to hold pre-woven cane in place. Measure the width of the groove in the chair and deduct enough to allow for the thickness of the cane. Sold by the foot.

S-408 #8 5/32"

S-409 #9 13/64"

S-410 #10 1/4"



Binder Cane

Used to finish edges of hand caned chairs. Can also be used to wrap legs of wicker furniture. Binder cane is sold in 25' package or 500' hank.

Medium 7/32"



S-505 25' Package

S-50500 500' Hank



S-810 Caning Pegs

Tapered caning pegs are 3" long. Sold in packages of 25.

Tools



S-840 Spline Removing Chisel

Used to remove the old spline from chairs with pre-woven caning. Tempered steel blade with plastic handle. Blade Width: 1/8"



S-770 Nail and Tack Spacer

Set up to 5 nails at a time without damaging the furniture or your fingers. Exact spacing.



MF-478 Scratch Awl

We have used this awl on everything, from starting holes for escutcheons pins and seat tacks to piercing leather. The blade on this awl is 2" long and the overall length is 3-7/8". Sharp pointed, tempered blade. Hardwood handle.

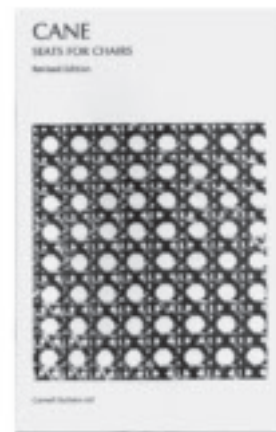

S-850 Caning Booklet

This 18 page booklet with more than 50 photos has complete instructions for hand weaving caned chair seats. The book also includes instructions for installing prewoven cane.

Polishes and Cleaners



CM-16 Williamsville Lemon Oil Beeswax

Williamsville Lemon Oil Beeswax Furniture Polish. This early American recipe "feeds" as it polishes by replacing natural oils that dry out over time in wood and finishes, and provides lustrous beeswax protection without buildup. Williamsville Wax is unequalled for the care, protection and preservation of fine furniture and woodwork. 8 Oz. Bottle



Antique Refinishers Wood Cleaner

Removes years of wax, dirt, grease, grime, and polish build-up. Will often restore furniture to its original beauty without stripping or refinishing. After cleaning the finish, apply Williamsville Lemon Oil Beeswax to preserve and protect the wood.

CM-10 16 Oz. Can Wood Cleaner



Nevr-Dull Polish

Magic wadding polish for brass, gold, silver, aluminum, copper, pewter, steel, and chrome.

ND-2 5 Oz. Can

Briwax



Briwax is the ideal product to stain, seal and finish new wood in one easy step. Produces a deep lustre wax finish. Briwax can also be used to clean and recondition all finished woods. Briwax will also remove nicks, scratches and watermarks. One Pound Can.

BRW-1 Clear

BRW-2 Light Brown

BRW-3 Dark Brown

BRW-4 Antique Mahogany

BRW-5 Golden Oak

BRW-6 Rustic Pine

Restoration Supplies

Darkening Solutions



Brass Ager

Used to darken polished brass hardware. A must when replacing antique furniture hardware. Can also be used on steel or zinc.

M-3 8 Oz
M-3Q 32 Oz



Nickel Ager

Ideal for darkening new nickel plated hardware on Hoosier cabinets.

M-3NA 8 Oz



Tin Ager

Used to darken pie safe tins and other new tin items.

M-3T 8 Oz.
M-3TQ 32 Oz.

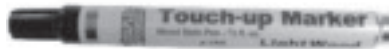

Touch-Up Markers

These touch-up markers cover surface scratches, watermarks, worn edges and other imperfections on all types of furniture and woodwork. They contain the same stain-like permanent dye used by professional craftsmen.

RA-855 Light
RA-856 Medium
RA-857 Dark
RA-858 Reddish



Putty Pencils

These putty pencils work because they are a blend of six waxes that are saturated with rich colorants. Simply rub over the scratch, joint or nail hole and wipe away excess with a cloth.

RA-813 Maple
RA-814 Oak
RA-815 Early American
RA-816 Cherry
RA-817 Red Mahogany
RA-818 Dark Walnut



RA-942 Miracle Wood Filler

Miracle Wood is made with natural wood fibers to look and perform like real wood. Formulated for fast set-up and drying. It accepts stain so well Miracle Wood filler comes in one natural color. 1.75 Fl. Oz



RA-801 Scratch Repair Kit

This complete repair kit contains four wax sticks of selected wood tones. Begin by rubbing across the scratch with a lighter stick and changing to the darker sticks as you go the colors blend to match the original wood shade. Use the included scraper to remove excess wax and buff with a soft cloth.



DP-4 Dental Picks

Stainless steel dental picks. Ideal for cleaning and detailing hard to reach areas. Set of 4.



Stripping Brushes

These handy brushes can be used for many applications such as stripping hard to reach areas. Wood handles are 8" long.

SBB-2W Brass
SBS-2W Stainless Steel

EZ-Bond cyanoacrylate adhesives can be used for almost any material including woods and veneers, vinyl, metals, plastic, glass, china, porcelain, stone, fabrics, etc. The quick curing action and excellent bonding strength make them ideal for furniture repair and restoration. Clamping is not required.



CA-120 is a thin viscosity glue with very good penetrating capabilities. It provides excellent bonding on tight fitting joints for most materials. Curing time is 3 to 5 seconds.

CA-120 E-Z Bond Thin 2 Oz. Bottle

EZ-BOND ACCELERATOR



CA-201 EZ-Bond Accelerator
Fast acting mild accelerator forces all cyanoacrylate glues to cure instantly. Expands gap filling capabilities. 2 Oz. Spray Bottle with sprayer



CA-801 EZ-Bond Accelerator Refill
Refill for EZ-Bond accelerator spray shown above. 8 Oz. Bottle



CA-220 is a medium viscosity glue with excellent gap filling capabilities. It fills gaps up to .005" and is the most popular grade. CA-220 cures in 15 to 20 seconds.

CA-220 E-Z Bond Medium 2 Oz. Bottle

ZIP KICKER AEROSOL SPRAY

ZIP KICKER is a special formula that sets the surfaces instantly when used with cyanoacrylate glues. It allows the forming of large fillets. ZIP KICKER is especially useful for applications where the positioning of the parts to be bonded is difficult.



PC-50 ZIP KICKER 5 Oz. Spray Can



CA-320 is a thick viscosity glue that is excellent for filling large gaps up to .007". This glue works well on most materials and cures in about 45 seconds.

CA-320 E-Z Bond Thick 2 Oz. Bottle



CA-20 EZ-Bond Debonder
EZ-Bond debonder will remove cured cyanoacrylate glues from skin and work surfaces. A few drops will dissolve the cyanoacrylate.

5 MINUTE EPOXY



EPX-5 5 Minute Epoxy
Quick-setting, high strength and waterproof. Includes a 2 Oz. bottle of resin and a 2 Oz. bottle of hardener,
Working Time: 3 Minutes
Set Time: 5 Minutes

Trunk Hardware

Trunk Handles



Leather Trunk Handles
1-1/8" Wide x 8-5/8" Long x 1/4" Thick
TKH-91 Black **TKH-92** Natural



Leather Trunk Handles Without Holes
1-1/8" Wide x 8-5/8" Long x 1/4" Thick
TKH-97 Black **TKH-98** Natural



Leather Trunk Handles
1" Wide x 9-1/4" Long x 1/4" Thick
Ends are 1-3/4" Wide
TKH-93 Black **TKH-94** Natural



Leather Trunk Handles
1" Wide x 8-7/8" Long x 1/4" Thick
TKH-95 Black **TKH-96** Natural

Trunk Straps



Leather Trunk Straps
Heavy top grain leather trunk straps with creased edges.
Brass plated buckle. Size: 1" x 60"
TKS-61 Black **TKS-62** Natural

Trunk Handle Loops



Handle Loop with Pin
1-1/4" W x 3-1/4" L
TKH-72 Brass Plated
TKH-72N Nickel Plated
TKH-72AB Antique Brass



Handle Loop
2-1/4" W x 2-1/16" L
TKH-76 Brass Plated
TKH-76N Nickel Plated



Handle Loop, No Pin
1-1/4" W x 3-1/4" L
TKH-73 Brass Plated
TKH-73N Nickel Plated
TKH-73AB Antique Brass



TKH-78B Handle Loop
Stamped Star Pattern
Dark Brown Steel
2-1/4" W x 2" L



TKH-74 Handle Loop
Brass Plated
2-1/4" W x 2-1/16" L



Trunk Handle Loops
1/2" W x 1-7/8" L
TKH-75 Brass Plated
TKH-75N Nickel Plated

NOTE: Use **TKH-75** and **TKH-75N** Handle Loops with **TKH-93**, **TKH-94**, **TKH-95** and **TKH-96** Trunk Handles.



Leather Strap Keepers
4-3/8" Long x 1-3/4" Wide
TKS-31 Black
TKS-32 Natural

Trunk Hardware

Trunk Locks



Flush mounted trunk lock with key. 3-3/4" x 6-5/8"
TKL-1 Brass Plated
TKL-1AB Antique Brass
TKL-1N Nickel Plated



Flush mounted trunk lock with key. Spring loaded. 3-3/4" x 4-3/4"
TKL-3 Brass Plated
TKL-3N Nickel Plated
TKL-3AB Antique Brass

Trunk Drawbolts



TKD-34 Drawbolt
 Brass Plated
 1-1/2" x 2-3/4"



Drawbolt
 1-3/4" x 3-1/4"
TKD-33 Brass Plated
TKD-33AB Antique Brass
TKD-33N Nickel Plated

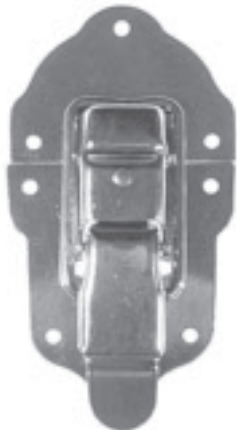

TKD-31 Drawbolt
 Brass Plated
 2-7/8" x 5-1/8"



TKD-50 Trunk Latch
 Polished brass latch with spring lever to secure the catch.
 Latch: 1-7/8" H x 1-7/8" W
 Catch: 1-7/8" H x 3/4" W

Trunk Hinges



TKH-66 Trunk Hinge
 Reproduction of a trunk hinge from the early 1900s. Hinge is 4" x 1-1/4" fully open. 18 Ga. Plain Steel



TKH-67 Trunk Hinge
 Reproduction of a trunk hinge from the early 1900s. Hinge has an 1/8" offset about 1" from the end of the short leaf. Hinge is 6-1/2" x 1-1/2" fully open. 16 Ga. Plain Steel



Stop Type Trunk Hinge
 Stamped steel trunk hinge with stops to hold lid at approximately 90 degree position. 1-1/2" x 3-1/4"
TKH-63 Brass Plated
TKH-63N Nickel Plated

All trunk hinges are sold each.

Trunk Hardware

Trunk Clamps



Trunk Clamp
Plated Steel. 5/8" Wide
Each Leg 1-7/16" Long
TKC-20 Brass Plated
TKC-20N Nickel Plated



Trunk Clamp
Brass Plated, 1-1/2" Wide
Each Leg 2" Long
TKC-26 Brass Plated
TKC-26N Nickel Plated
TKC-26AB Antique Brass

Trunk Corners



TKC-31 Trunk Corner
Brass Plated
1" x 1" x 1"



TKC-35 Trunk Corner
Brass Plated Steel
2-1/8" x 2-1/8" x 2-1/8"



Trunk Corner
1-1/4" x 1-1/4" x 1-1/4"
TKC-32 Brass Plated
TKC-32N Nickel Plated



Trunk Corner
1-3/4" x 1-3/4" x 1-3/4"
TKC-34 Brass Plated
TKC-34N Nickel Plated



TKC-36N Trunk Corner
Nickel Plated Steel
2-1/8" x 2-1/8" x 2-1/8"

Wood Trunk Slat



TKW-90 Plain Hardwood Trunk Slat
2-1/4" Wide x 1/4" Thick with quarter round edges.
36" Long.

Slat Clamps for Antique Trunks

The four slat clamps below are reproductions of the originals taken from an 1898 trunk. Stamped plain steel. Clamps fit slats 2-1/8" to 2-1/4" wide.



TKW-30 Trunk Slat Clamp
Covers one end of wood slat.
2-1/4" Wide x 3" Long



TKW-40 Trunk Slat Clamp
Covers seam where one wood slat
meets perpendicular with another
slat. 2-1/2" Wide x 2-1/4" Long



TKW-50 Trunk Slat Clamp
Clamps wood slats to the top of trunk.
2-9/16" Wide x 3-3/8" Long



TKW-60 Trunk Slat Clamp
Covers wood slats to the top of the trunk
and bends over the side of the lid.
2-1/2" Wide x 5-3/8" Long

Trunk Hardware

Trunk Rollers



TKR-19 Trunk Roller
Plain Steel, 5/8" x 1-3/4"
Roller Diameter: 5/8"



TKR-17 Trunk Roller
Plain Steel, 1" x 2"
Roller Diameter: 3/4"



TKR-30 Trunk Roller
Cast brass trunk roller.
Overall Size: 3-3/16" High x
7/8" Wide x 1-1/2" Deep.
Upper Leg: 2-1/2"
Lower Leg: 1-3/16"

Trunk Bottom Studs



TKS-11 Bottom Stud
Brass Plated Steel
7/8" Diameter, 5/8" Pin



TKS-13 Bottom Stud
Brass Plated Steel
1-1/2" x 2"

Trunk Nails and Tacks



Trunk Nails

Brass Plated Steel.
Sold in 4 Oz. Packages.
TKN-1 1" Approx. 115 per 4 Oz.
TKN-2 1-1/2" Approx. 80 per 4 Oz
Plain Steel Trunk Nails.
TKN-1S 1" Approx. 115 per 4 Oz



Trunk Tacks

Brass Plated Steel.
Sold in 4 Oz. Packages.
TKT-8 1/2" Approx. 200 per 4 Oz.
TKT-9 3/4" Approx. 130 per 4 Oz.
TKT-10 1" Approx. 105 per 4 Oz.
Plain Steel Trunk Tacks
TKT-9S 3/4" Approx. 130 per 4 Oz



Trunk Rivets

Brass Plated, 3/8" Head, 5/32" Body
Diameter. Sold in packages of 50.
TKR-12 1/2" Long
TKR-14 3/4" Long
TKR-15 7/8" Long
TKR-18 Rivet Caps



TKN-6 Decorative Nail
1/2" Head, 1/2" Long



TKN-7 Decorative Nail
1/2" Hammered Head
3/4" Long

Trunk Lid Stays



TKS-36

TKS-37

Brass plated lid stays for trunks.
TKS-36 1" x 8" Fully Open
TKS-37 7/8" x 6-3/4" Fully Open

Nickel plated trunk lid stay.
TKS-37N 7/8" x 6-3/4" Fully Open

Trunk Ornament



TKO-40 Trunk Ornament
Stamped plain steel trunk
ornament. Diameter: 1-7/8"

Index

Adhesives	15, 67	Jar Lids	11, 12
Appliques, Oak	59 thru 61	Jars	11, 12
Architectural Hardware	55, 56	Keyholes	25, 36, 55, 58
Art Deco Hardware	27	Keys	40, 41, 56, 57
Bail Mounting Hardware	52	Knobs	9, 15, 26, 27, 28, 30 thru 35
Bail Sets	22 thru 24	Latches	3, 6, 7, 9, 33, 56
Claw Feet	49	Legs	10
Bed Hardware	45	Leather Trunk Handles	68
Bells	51	Lid Stays	54, 71
Bin Pulls	2, 9	Locks	37, 38, 39, 57, 69
Bookcase Hardware	44	Metal Polish	65
Brass Ager	66	Mirror Supports	54
Brass Polish	65	Mission Hardware	24, 28
Bread Drawers	17	Morris Chair Parts	62
Briwax	65	Nails	52, 53, 62, 70
Cabinet Latches	3, 6, 7, 33	Nickel Ager	66
Caning Supplies	64	Oak Appliques	59 thru 61
Casters	4, 5, 10	Period Hardware	22 thru 28
Catches	6, 7, 54	Pie Safe Tins	50
Chair Parts	62 thru 64	Polishes	65
Chair Seats	63	Porcelain Knobs	34
Chippendale Hardware	25	Restoration Supplies	65, 66
Claw Feet	49	Ring Pulls	25, 26, 29
Coat Hooks	46, 47	Screws	35, 53
Cupboard Latches	3, 33	Screw Hole Plugs	58
Cupboard Turns	33	Seats, Fiberboard	63
Desk Bells	51	Shaker Pegs	58
Desk Handles, Oak	58	Shelf Rests	54
Desk Hinges	42	Side Brackets	14
Desk Lid Supports	54	Spice Jars	11
Desk Locks	37	Spool Cabinet Knobs	31
Door Charts	18	Spool Cabinet Decals	51
Door Pulls	9, 24 thru 29, 33	Sugar Jar Lids	11, 12
Drawer Pulls	9, 15, 22 thru 29, 33, 58	Sugar Jar Racks	11
Drawer Stops	54	Table Hardware	48, 49
Drawbolts	69	Tambour Doors	15
Drops	25, 26, 29	Tape, Tambour Door	15
Duncan Phyfe Caps	49	Tin Ager	50, 66
Eastlake Hardware	23, 25	Touch-Up Sticks	66
Eye Bolts	16, 52	Trunk Hardware	68 thru 71
Fiberboard Seats	63	Victorian Hardware	23, 26
File Cabinet Hardware	44	Waterfall Hardware	27
Flour Sifters	16	Wire Racks	11
Furniture Glides	54	Wood Appliques	59 thru 61
Furniture Polish	65	Wood Cleaner	65
Glass Handles	35	Wood Drawer Pulls	28, 58
Glass Knobs	9, 34, 35, 56	Wood Filler	66
Glue	15, 67	Wood Keyholes	36, 58
Hepplewhite Hardware	24	Wood Knobs	28, 32
Hinges	8, 9, 27, 42, 43, 55, 69	Wood Parts	58
Hooks	10, 46, 47, 54	Wood Picture Frame Corner	58
Hoosier Cabinet Book	20	Wood Screws	53
Hoosier Cabinet Hardware and Parts	6 thru 20		
Hoosier Cabinet Kit	19		
Ice Box Hardware	21		
Ice Box Kit	21		

Kennedy Hardware

ORDERING INFORMATION

This catalog contains our complete line of restoration hardware for Hoosier cabinets, antique furniture and trunks. The design or specifications for any product in this catalog is subject to change by the manufacturer. If you have any questions concerning the hardware shown in this catalog, please feel free to write or call. Refer to the enclosed price list for current prices of the items shown in this catalog.

PHONE ORDERS: Our Toll Free order line **1-800-621-1245** is available from 9:00AM to 4:00PM Eastern Time Monday through Friday. Please have your order ready before calling our Toll Free order line. For information or other business call **1-317-873-1316**.

FAX ORDERS: Our FAX line **1-317-873-8662** is available for orders 24 hours a day.

MAIL ORDERS: Mail order to Kennedy Hardware, 10655 Andrade Drive, Zionsville, IN 46077.

ON-LINE ORDERS: www.kennedyhardware.com

DISCOUNT POLICY: We offer additional discounts based on the total amount of your order. See current price list. Dealers: Call or write for information about our **PREFERRED DEALER** program.

TERMS: Check, Money Order, Visa, MasterCard, Discover, or American Express.

SHIPMENTS: Orders received by mail are normally shipped the next working day. Credit card orders that are received by 9:00AM Eastern Standard Time are normally shipped the same day. All items shown in this catalog are normally in stock.

SHIPPING CHARGES: Orders up to \$25.00	\$7.00
\$25.01 to \$50.00	\$8.50
\$50.01 to \$75.00	\$9.50
\$75.01 to \$100.00	\$10.50
\$100.01 to \$150.00	\$14.00
\$150.01 to \$200.00	\$17.50
\$200.01 to \$250.00	\$19.50
\$250.01 and up	8% of Total Order

NOTE: Actual shipping charges will apply for oversize cartons, and large quantity orders of Brass Ager, Tin Ager, Fiberboard Seats and Wood Casters. See the current Price List for Special Shipping Charges.

International Orders: Shipping charges for all international orders will be actual US Mail or UPS shipping charges. International customers are responsible for General Sales Tax, Import Duties and Brokerage Fees.

SALES TAX: Indiana residents add 7% Sales Tax. Indiana dealers include Sales Tax Exemption Certificate (Form ST-105) with first order.

RETURNS: You may return any item within 30 days of the date the order was shipped. If you wish to return an item, call for a Return Merchandise Authorization (RMA) number. When returning any item, enclose a copy of the original invoice and the reason for return. All items must be returned in the same condition as they were received. Special orders are not returnable. All returns should be shipped to the above address.

UNAUTHORIZED RETURNS WILL BE SUBJECT TO A RESTOCKING CHARGE OF UP TO 20%.

DAMAGED SHIPMENTS: If a package is opened or damaged when you receive it, inspect the merchandise in the presence of the UPS driver. In case of damage, ask the driver to file a damage claim.



Polished Brass



Nickel Plated



Brushed Nickel



Oil Rubbed Bronze



Antique Copper